

Es. 1 $\pi_2 = PV$

$\pi_3 = PL$

Parallelepipedo

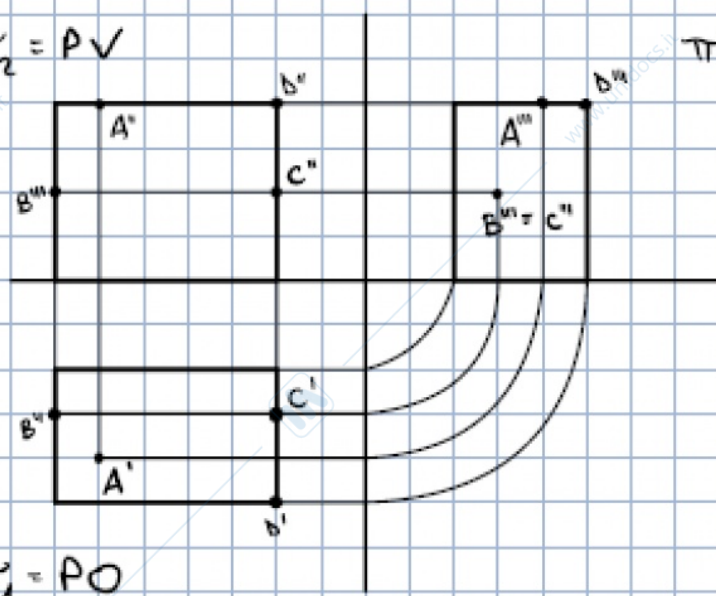

$\pi_1 = PO$

Es. 2 PV

PL

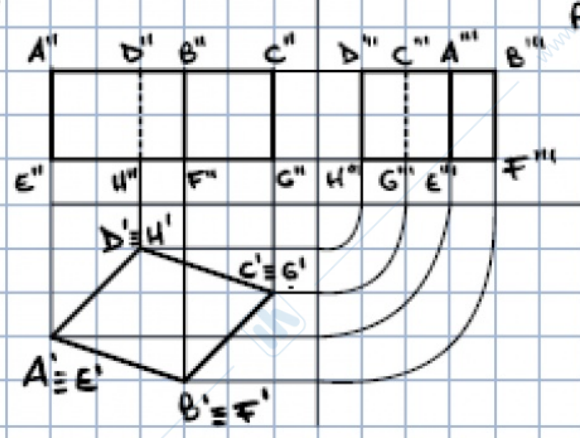

PO

Es. 3 PV

PL

Cubo

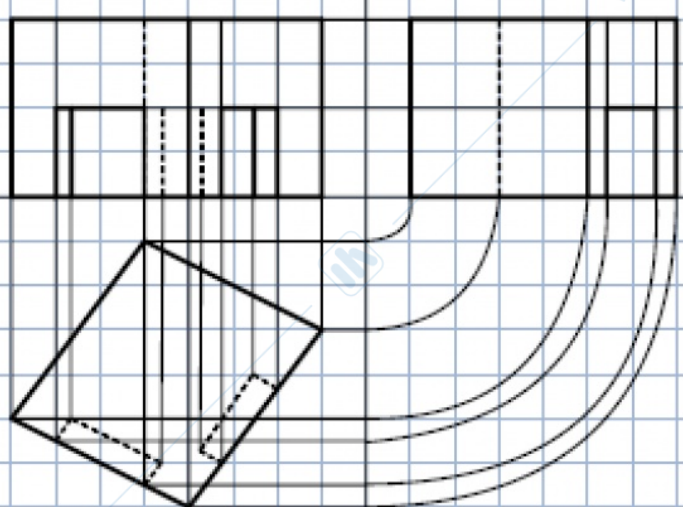

PO

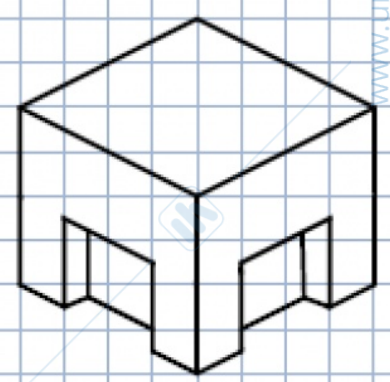

Es. 4

PV = π_2

PL = π_3

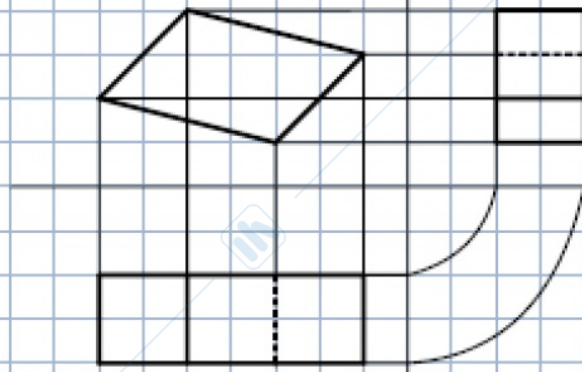

PO = π_1

Es. 5

PV

PL

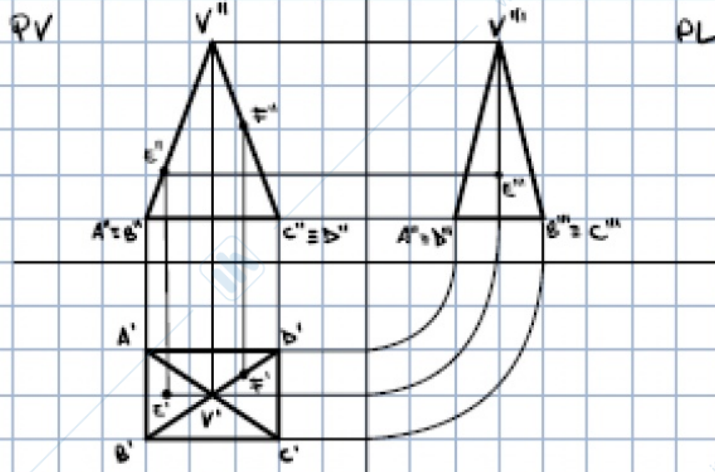

Asse di simmetria
tratto-punto

PO

Es. 6

PV

PL

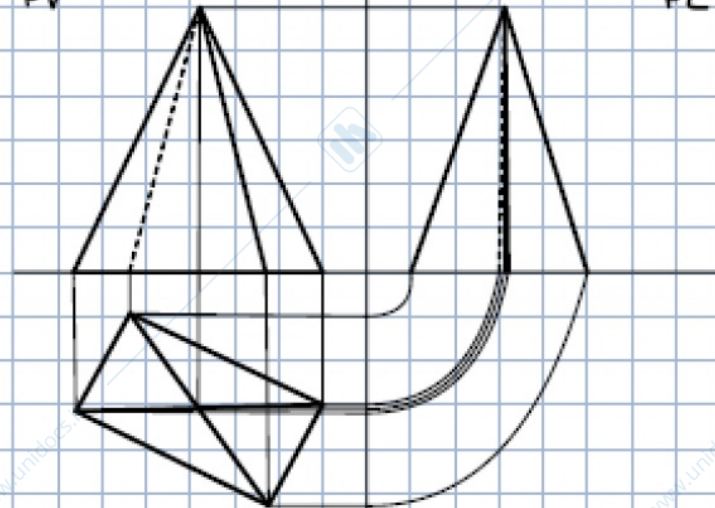

PO

Es. 7

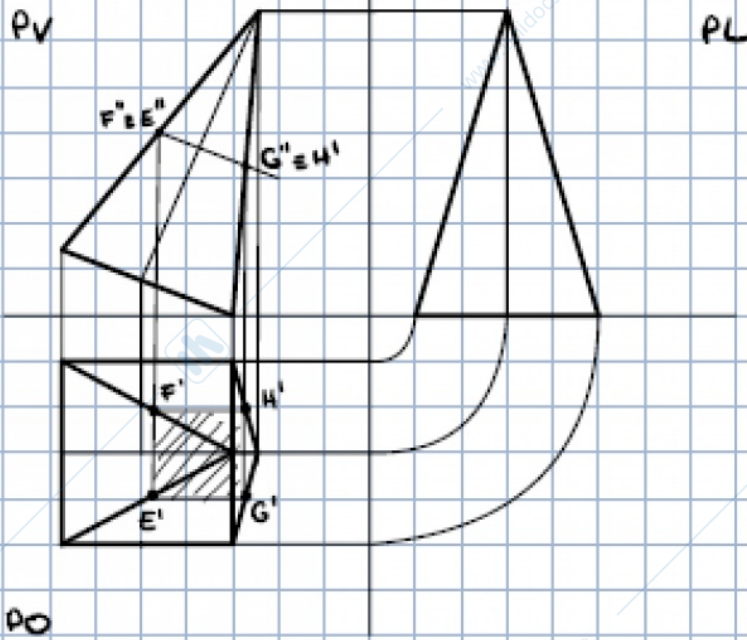

Es. 8

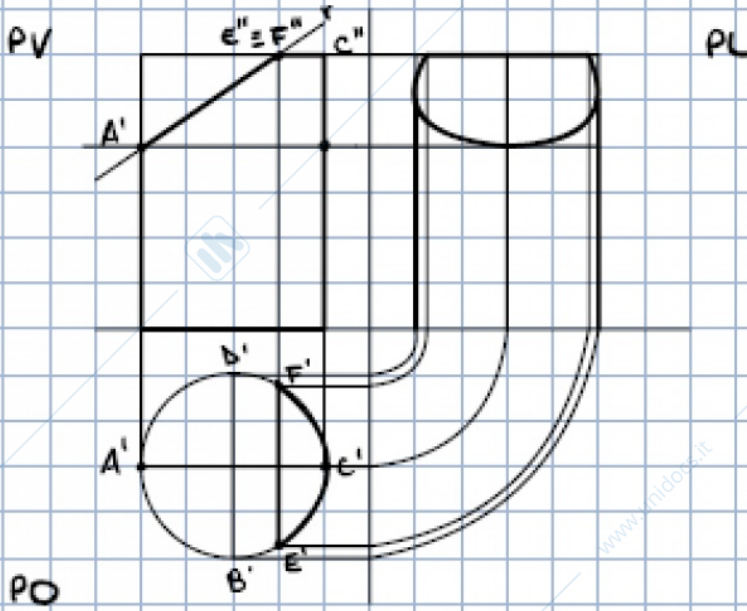

Es. 9

