

This article was downloaded by: [Politecnico di Milano Bibl], [dario coronelli]

On: 13 May 2015, At: 01:08

Publisher: Taylor & Francis

Informa Ltd Registered in England and Wales Registered Number: 1072954 Registered office: Mortimer House, 37-41 Mortimer Street, London W1T 3JH, UK

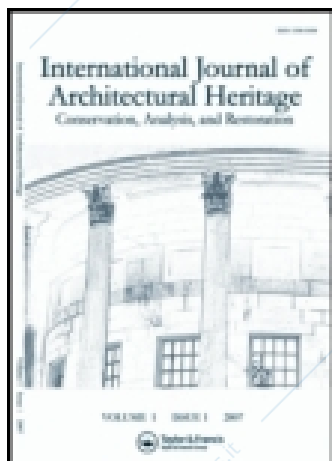

International Journal of Architectural Heritage: Conservation, Analysis, and Restoration

Publication details, including instructions for authors and subscription information:

<http://www.tandfonline.com/loi/uarc20>

Cathedral of Milan: Structural History of the Load-Bearing System

Dario Coronelli^a, Benedetta Caggioni^b & Francesca Zanella^c

^a Department of Civil and Environmental Engineering, Politecnico di Milano, Milan, Italy

^b Politecnico di Milano, Milan, Italy

^c Milan Order of Architects, Milan, Italy

Accepted author version posted online: 09 Sep 2014. Published online: 09 Sep 2015.



[Click for updates](#)

To cite this article: Dario Coronelli, Benedetta Caggioni & Francesca Zanella (2015) Cathedral of Milan: Structural History of the Load-Bearing System, International Journal of Architectural Heritage: Conservation, Analysis, and Restoration, 9:4, 510-528, DOI: [10.1080/15583058.2013.821541](https://doi.org/10.1080/15583058.2013.821541)

To link to this article: <http://dx.doi.org/10.1080/15583058.2013.821541>

PLEASE SCROLL DOWN FOR ARTICLE

Taylor & Francis makes every effort to ensure the accuracy of all the information (the "Content") contained in the publications on our platform. However, Taylor & Francis, our agents, and our licensors make no representations or warranties whatsoever as to the accuracy, completeness, or suitability for any purpose of the Content. Any opinions and views expressed in this publication are the opinions and views of the authors, and are not the views of or endorsed by Taylor & Francis. The accuracy of the Content should not be relied upon and should be independently verified with primary sources of information. Taylor and Francis shall not be liable for any losses, actions, claims, proceedings, demands, costs, expenses, damages, and other liabilities whatsoever or howsoever caused arising directly or indirectly in connection with, in relation to or arising out of the use of the Content.

This article may be used for research, teaching, and private study purposes. Any substantial or systematic reproduction, redistribution, reselling, loan, sub-licensing, systematic supply, or distribution in any form to anyone is expressly forbidden. Terms & Conditions of access and use can be found at <http://www.tandfonline.com/page/terms-and-conditions>

Cathedral of Milan: Structural History of the Load-Bearing System

Dario Coronelli,¹ Benedetta Caggioni,² and Francesca Zanella³

¹Department of Civil and Environmental Engineering, Politecnico di Milano, Milan, Italy

²Politecnico di Milano, Milan, Italy

³Milan Order of Architects, Milan, Italy

The structure of the Cathedral of Milan is studied. The features of the building and the original aspects of its load-bearing system are discussed. The progressive development of the structural system is described following its historical phases through four centuries. The final configuration is then analyzed with its main load paths. Detailed information, collected during the 20th century restoration work, was used to determine the geometry and loads. Preliminary analyses are based on equilibrium principles, within the framework of limit analysis for masonry constructions. The main structural restoration works taking place during the life of the Cathedral of Milan are outlined. The results provide a basis for the verification of more detailed numerical analyses and a reference for restoration interventions. Furthermore, the introductory analyses presented here develop the knowledge for future studies devoted to the Cathedral of Milan, encompassing structural, construction, and architectural issues.

Keywords cathedral, load paths, arches, vaults, piers, limit analysis, masonry

1. INTRODUCTION

The structural system of the Cathedral di Milano is deeply related to the history of its construction, lasting four centuries, and to its life up to the present. Understanding the conditions of the structure and its members requires tracing back the main events over this time span, leading to its growth, the accumulation of damage in critical events, progressive deterioration, and the structural restoration of the Cathedral.

The construction started in 1386, developing mainly throughout the 15th and 16th century, though the final works took place in the 18th century. In 1774 the main spire was built, bearing the statue of the Virgin, the *Madonna*; the facade

Received February 23, 2013; accepted June 28, 2013.

Address correspondence to Dario Coronelli, Department of Civil and Environmental Engineering, Politecnico di Milano, Piazza Leonardo da Vinci 32, 20133, Milan, Italy. E-mail: dario.coronelli@polimi.it

Color versions of one or more of the figures in the article can be found online at www.tandfonline.com/uarc.

was finished for Napoleon Bonaparte's coronation in 1805; the last tower spires, the *gugliotti*, were built in the second half of the 19th century. The reports of the history are contained in the archives of the *Veneranda Fabbrica del Duomo* and several commentaries and studies have been issued in the Italian literature.

The story of the construction has been commented by Ackermann (1949), Frankl (1960), and Heyman (1996) among others. These works focus especially on the discussions on the configuration of the building, with the local builders contrasted by several invited experts from France, Germany, and other European countries, supporting the gothic tradition and experience. The same events have been studied more recently including the Cathedral within a number of constructions in Italy of the 15th and 16th century (Bradford Smith 1997).

The structural behavior has been studied more in detail in relation to major restoration works of the main piers starting in the 1960s, and producing in-depth technical documentation of great interest (Ferrari da Passano 1988). These have not been reported much in the International literature. The main problem to be solved was that of foundation settlements causing over-stress of the piers of the crossing, with the consequent damage (Binda 2008). Recent interventions to restore the main spire of the Cathedral have given rise to new studies focusing mainly on this part of the building (Calvi et al. 2003; Giorgetti and Postoli 2012).

The aim of this discussion is a global description of the load bearing system of the Cathedral with its main features, following the construction phases and finally the recent restoration works. Similar studies have been dedicated in the literature to relevant European cathedrals, such as those by Courtenay (1997) and Roca et al. (2013), among many others. Rather than the alternatives proposed during the course of this history and the related debates, the final choices of the builders are shown and studied.

The method used is that of understanding the load paths qualitatively first (Schodek 2004) and then by static analysis including quantitative calculations. These introductory analyses are based on equilibrium and limit analysis of structural schemes

of different parts of the cathedral (Heyman 1995; Huerta 2001), to establish the stability of the construction. A simplified though accurate geometrical model has been drawn, and the loads calculated. Detailed data on the geometry were gathered from drawings in the literature and technical documentation of the Veneranda Fabbrica del Duomo used as a basis of the 20th century structural restoration works (Ferrari da Passano and Brivio 1967; Ferrari da Passano 1988). The result is a synthesis of the global structural response, providing a reference for more detailed analyses describing more accurately the geometry and configuration and considering sequential phases, accumulation of damage and long-term structural response (Roca et al. 2010; Roca et al. 2013). The study of the structural performance linked to the evolution of the construction and the life of the building provides also a basis for historical and restoration studies (Smith 2001).

Following this Introduction, in the second section the global layout and the main elements and parts are identified on the basis of their geometry and structural action. The third section describes the progressive development of the structural system, following its historical phases through four centuries: from the foundations to the piers and vaults; then the building of the tiburio and dome supporting the main spire. In the fourth part the final configuration is then analyzed with its main load paths, and the needs for further analyses are discussed. A fifth section describes the main restoration works taking place during the life of the structure of the Cathedral, followed by the conclusions.

2. GEOMETRY AND STRUCTURE OF THE CATHEDRAL

This section contains an overall description of the geometrical and structural configuration of the Cathedral. In addition some features of the foundations, vertical elements and vaults will be described; these are common to all parts of the building, and will be recalled in the story of the structure and its construction in Section 3.

Amongst other contemporary European cathedrals, the Cathedral is notable for several particular features. The building is amongst the largest churches ever built. In all vaults and arches iron ties are used; the lateral thrusts from the vaults are resisted by these members, together with transverse diaphragm walls that transfer the outward forces to the lateral buttresses. The flying buttresses and pinnacles that can be seen today were added late in its history starting from the 18th century, and are not necessary for the structural stability. A system of double vaults is used for the naves, the apse and the tiburio: ribbed vaults in the interior and outer barrel vaults; the latter make up the stone roof of the cathedral. The high vaults have a strong curvature in the transverse direction, with small clerestory windows. Last but not least, a choice that deeply influenced the life of the construction was that to support the tiburio, with the dome and main spire, on four piers alone. Moreover the cross-section of these members in the original intention would have been the same as that of all the other piers in the construction; finally they

were built only moderately larger. These features are described in the following.

2.1. Plan and Elevation

The plan of the Cathedral (Figure 1a) is a Latin cross running longitudinally from East to West. It is based on the repetition of a square module of 16 Milanese *braccia* (9.6 m) along the whole length with the exception of the apse, with trapezoidal deambulatory modules around the semi-octagonal plan. The cathedral has five naves in the longitudinal direction and three in the transepts. The central nave has a width of 32 *braccia* (19.2 m) corresponding to a double module, both in the main nave and the transepts. Thus the crossing measures 19.2 by 19.2 m, supporting the dome and the main spire in elevation. The vaults are quadripartite rib-vaults on the 9.6-m square module in the lateral naves and 9.6 by 19.2 m in the main nave.

For the geometrical proportions in plan, the apse with the choir circumscribes an equilateral triangle and is enclosed in its circumscribing circle (Figure 1a). The proportions of the elevation (Figure 1b-c) have been studied by Ackerman (1949), amongst others. It is determined by an equilateral triangle with the base equal to the width of the five naves and the height reaching the crown of the central nave. The geometry in elevation was based initially on a module with a height of 14 *braccia* (10.2 m). This scheme was used by the builders up to the height of 2 modules (28 *braccia*, 20.4 m), determining the height of the piers of the side naves. Then the construction continued using Pythagorean triangles with a height of 12 *braccia* (7.2 m) and a width of 16 *braccia* (9.6m). The height of the piers at the springing of the arches in elevation is thus fixed at 28, 40, and 52 *braccia* (16.8 m, 24 m, and 31.2 m). The height of the naves is 40, 52, and 76 *braccia* (24, 31.2, and 56 m). The crown of the dome is at 108 *braccia* (64.8 m), 32 *braccia* (19.2 m) above the main nave, with a span of 32 *braccia* (19.2 m).

The overall dimensions are notable, together with the presence of five naves (Figure 2a-b). The building *de facto* is amongst the largest churches ever built. Considering other cathedrals of similar proportions, the main nave width of 19.2 m for instance (Figure 2c) is larger than in the more ancient cathedrals of Amiens (<1218) and Cologne (1248), or in Seville (1412–1519); the height of the main nave just above 45m is also notable, slightly higher than that of the quoted examples.

2.2. Foundations, Piers, and Walls

The perimeter foundations are continuous walls (Figure 3) made of *serizzo*—a metamorphic stone typical of the Southern Alps, reaching down to 7 m below the floor of the church, with 1m visible above ground on the exterior. The foundations under the piers take the form of truncated pyramids made of brick, reaching to 7 m below the floor of the church, where the water table was at the time of construction.

The ground layers are alluvial deposits, sand and gravel down to 120 m depth, with the exception of a layer of silt

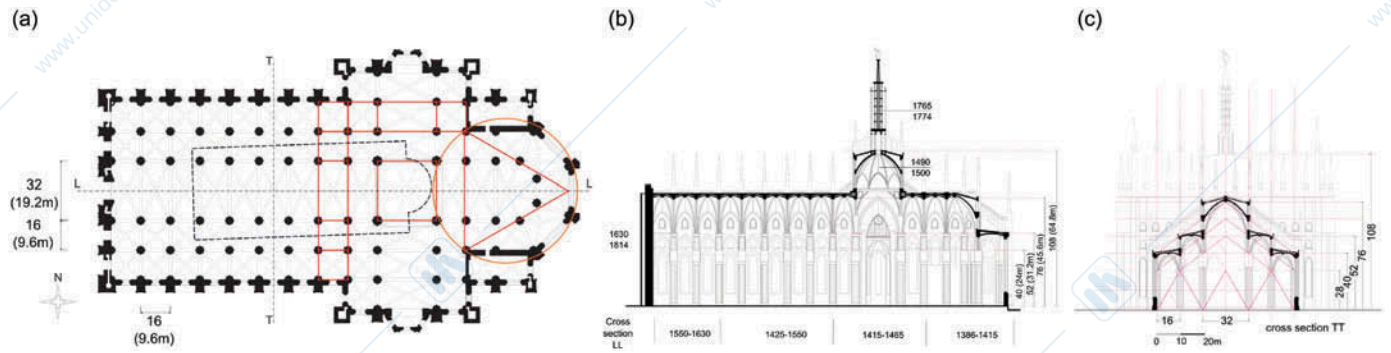

FIG. 1. Geometry: (a) plan (broken line: position of the previous Basilica of Santa Maria Maggiore); (b) longitudinal and (c) transverse sections. (Units are Milanese *braccia* = 0.6m; square module in plan of 16 *braccia* = 9.6m).

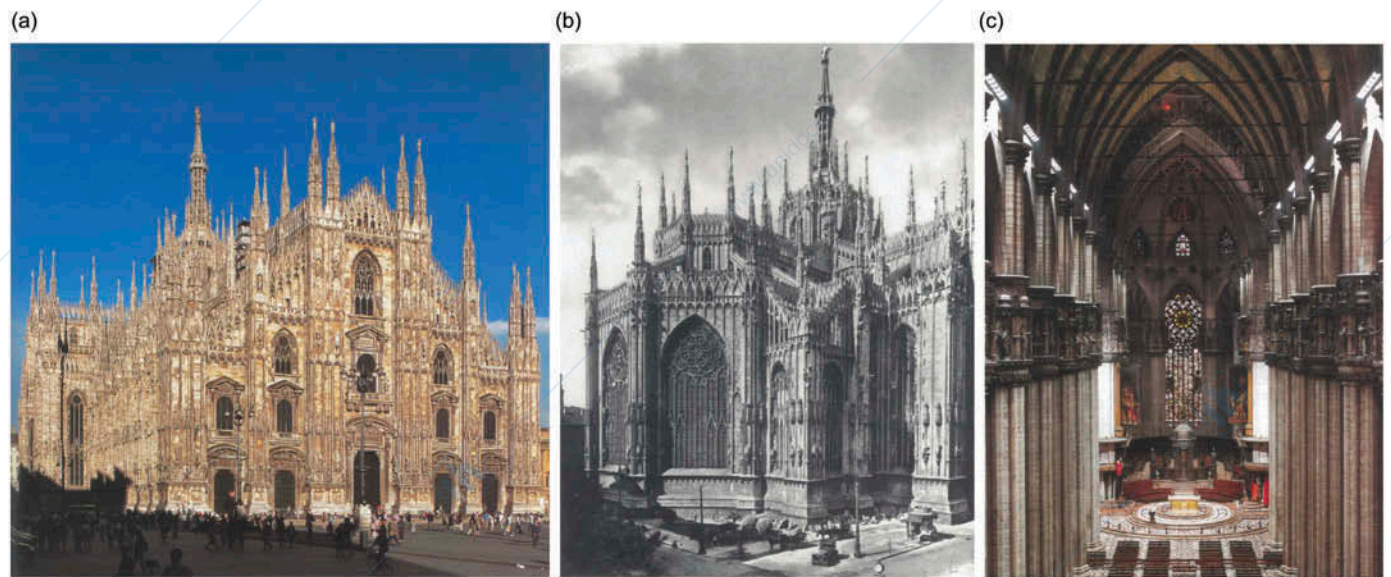

FIG. 2. Perspective views: (a) northwest; (b) northeast; (c) interior, main nave looking from west to east.

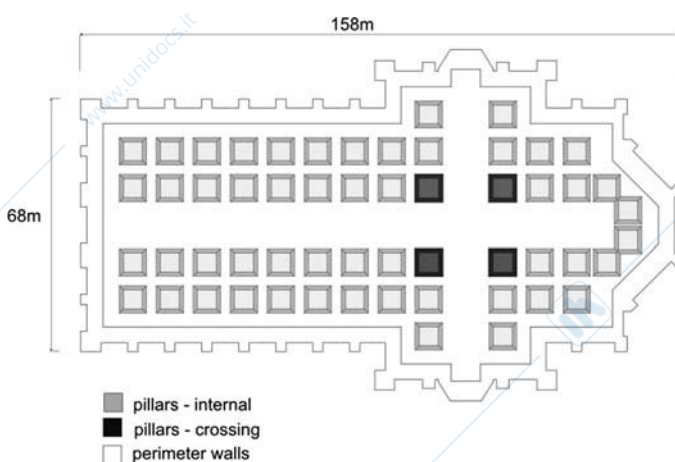

FIG. 3. Foundations.

between 9 and 11 m (Ferrari da Passano 1988). Information on typical soil properties in the area of Milan, including some tests for the Cathedral are reported by Niccolai (1967). Part of the foundations was laid on existing buildings. The previous basilica of Santa Maria Maggiore as an example extended between the Tiburio and the first 5 bays of the main nave (Figure 1a), and was gradually dismantled as the construction of the Cathedral proceeded.

The interior piers all have the same cross-section (Figure 4), inscribed in a circle with an outer diameter of approximately four *braccia* (2.55 m as built), with the exception of the four main piers of the crossing with an outer diameter of four and three quarters *braccia* (2.95 m as built). The intention at the beginning of the construction was to provide the same cross-section for all piers, including the four main piers of the crossing, meant to support the tiburio with the dome and main spire. A larger cross-section for these four members was proposed by Matteo da Campione in 1390, at the time master

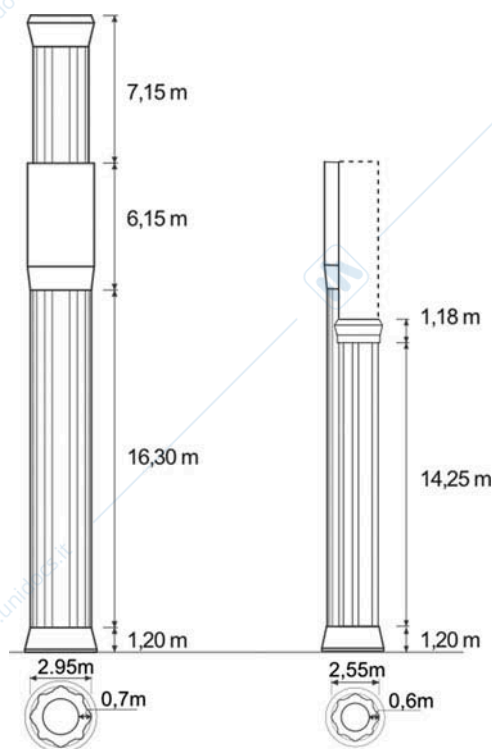

FIG. 4. Pier configuration and cross-section: (a) piers of the crossing supporting the Tiburio (vertical dimensions valid for all piers of the central nave, with diameter 2.55 m); (b) lateral piers between the side naves.

mason of the Cathedral of Monza. The diameter was increased by $\frac{3}{4}$ of *braccia*, with a 33% increment of cross section (6.8 m^2 with respect to 5.1 m^2) of relevant importance for the future history of the Cathedral. Detailed calculations of the load supported by these members at the end of the construction show that it is the double of that of the other piers, approximately 3000 versus 1500 tons (Section 4).

The choice described above to limit the dimensions of the piers of the tiburio contrasts with the practice in many other cathedrals. The wider portion of the building to be supported is evident from the examination of the plan, which, in other constructions, shows an evident increase in the size of the piers at the crossing. This is even more surprising considering that the tiburio and dome, supported on these members, were already in the original plans at the beginning of the construction. Moreover these elements suffered the most damage throughout the life of the construction, described in the following, until the 20th century restorations (Section 5).

The cross section of all piers is made of an outer Candoglia marble ring and a core of blocks of serizzo mixed with rubble made of mortar, brick and pieces of marble. Both types of stone are original of the area of lake Maggiore, north of Milan. The strength and weight per unit volume of Candoglia and serizzo are similar, though the Young's modulus is higher for the former—with nominal values of 50 and 9 GPa respectively. The material properties were measured during the restoration

works in the 1960s and are the object of test reports available in the archive of the Veneranda Fabbrica del Duomo (Istituto Sperimentale Modelli e Strutture [ISMES] 1802 [1982]). Material testing throughout the years has shown that the material properties of stone presently quarried in Candoglia—still owned by the Fabbrica and used for the repairs—are the same of those of the material of the Cathedral.

The outer Candoglia rings show courses with height variable from 26 to 60 cm and thickness between 20 and 90 cm, measured during the 20th century restorations (Ferrari da Passano 1988), as also discussed in Section 5). The procedure used was drilling the marble with a 6-mm point, in order to determine the thickness of the outer ring and of the inner core, carried out on a grid of points distributed over the whole pier surface. The variations in the thickness were caused by the quantity of material available, varying in time with the supplies and the economic resources. The blocks inside the piers were frequently placed without taking care of a correct orientation of horizontal and vertical planes in relation to the material properties. Poor quality mortar was interposed between the courses of the outer marble; being the surfaces of the block not perfectly even, this caused contacts between the blocks, increasing in time with shrinkage of the mortar. Hence the irregular surface working of the blocks was detrimental too, causing stress concentrations and damage of the stone.

As already mentioned, the builders chose two equally strong materials, serizzo and Candoglia, being ignorant though of the difference in the Young's modulus. Moreover they did not take into account the problems related to skin and rubble construction with the slump of the inner material and overloading of the outer ring. Restoration works carried out in the twentieth century showed that the two parts of the pier were quite badly connected, hence with a minimal composite action (Ferrari da Passano 1988). The evolution in time of the damage in these members and the restoration are described in the following Sections 3 and 5.

2.3. Vaults and Arches

All longitudinal and transverse arches are pointed (Figure 4), made of Candoglia marble. The same cross section was used for all such members in the naves: the width is 1.05 m; for the depth, these members are made of Candoglia voussoirs approximately 0.5 m deep, above which brick walls have been built. The geometry of these walls is explained more in detail in the following. The pointed arches along the four sides of the crossing have greater depth, equal to 1.3 m. Iron tension ties were provided for all arches in the building from the beginning of the construction.

The vaulting system of the central nave is made of double vaults (Figure 5), superimposed at two different levels in elevation, one covering the interior of the church and the other above supporting the stone roof. Figure 5a shows that also each side nave has a double brick shell, in the half towards the interior,

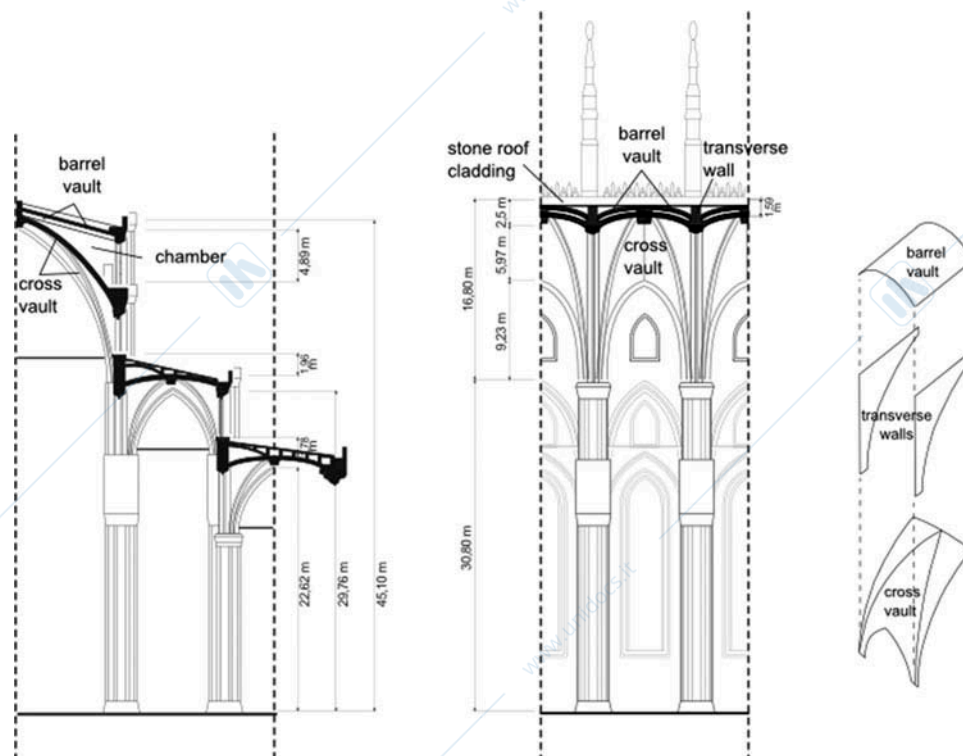

FIG. 5. Double vaults of the naves (drawn without flying buttresses, as shown in Figure 6): (a) transverse cross-section; (b) longitudinal cross-section; (c) scheme of the double vaults.

accommodating the inclination of the stone roof. The dome of the tiburio and the vaults of the apse have similar systems of double vaults, as can be seen in Figures 1b-c and described in the following Section 3.

The interior vaulting system in the naves is made of quadripartite rib-vaults, with transverse and longitudinal arches and diagonal ribs. The main nave has nearly even-crown vaults in the longitudinal direction (Figure 5b), with the crown of the vault approximately 1 m above that of the transverse arches. In the transverse direction the webs have a relevant curvature, with the crown at approximately 6 m in the vertical direction from their supports on the lateral walls above the nave arcade. In the lateral naves with square plan, the crowns of the transverse and longitudinal arches are slightly lower than that of the vault.

The second outer series of vaults is made of barrel vaults. Each module of the quadripartite vaults in the main nave is covered by such a vault spanning in the East to West direction, supported on transverse walls at two ends, built above the transverse arches (Figure 5c). To obtain the roof pitch the barrel vaults axis is inclined in the transverse direction (Figure 5a). The double vaulting creates a row of chambers all along the nave. A similar scheme is used for the transepts, choir and apse. The roof is made of stone laid on the outer vaults, forming a terrace on top of the cathedral with pitches that are slightly inclined.

The weight of the upper barrel vaults increases the resultant of vertical loads, with respect to that of a timber roof— frequently used to cover the vaults in many similar buildings. Ferrari da Passano (1988) stated that the load increase due to the barrel vaults makes the resultant forces at the support on the piers more vertical, in the sum with the horizontal thrust of the quadripartite vaults. This would, according to this author of this article, reduce the cross-section necessary for the piers, reduce the tension of the ties of the arches and eliminate the need of flying buttresses. Moreover Ferrari da Passano (1988) and Beltrami (1881–1914 [1964]) underline that the flying buttresses of the Cathedral are not necessary for the structural stability. Their position in fact (Figure 6c) is high above the points where the lateral thrusts act. Archive researches suggest and Bradford Smith (1997) amongst others reports that they were added in the 19th century, as confirmed by historical drawings (Figure 6b).

The shape and position of the transverse walls supporting the barrel vaults must be considered (Figure 6a-b). The intrados has the shape of the transverse pointed arches of the nave, and the extrados the inclination of the roof (Figure 6c-d, points 1-5). These walls develop arch action, transferring their self-weight and that of the barrel vaults to the supports above the piers (Figure 6d, point 5) with both a vertical component and a horizontal thrust. Simple equilibrium calculations based on the load resultant indicate that these vertical and horizontal forces

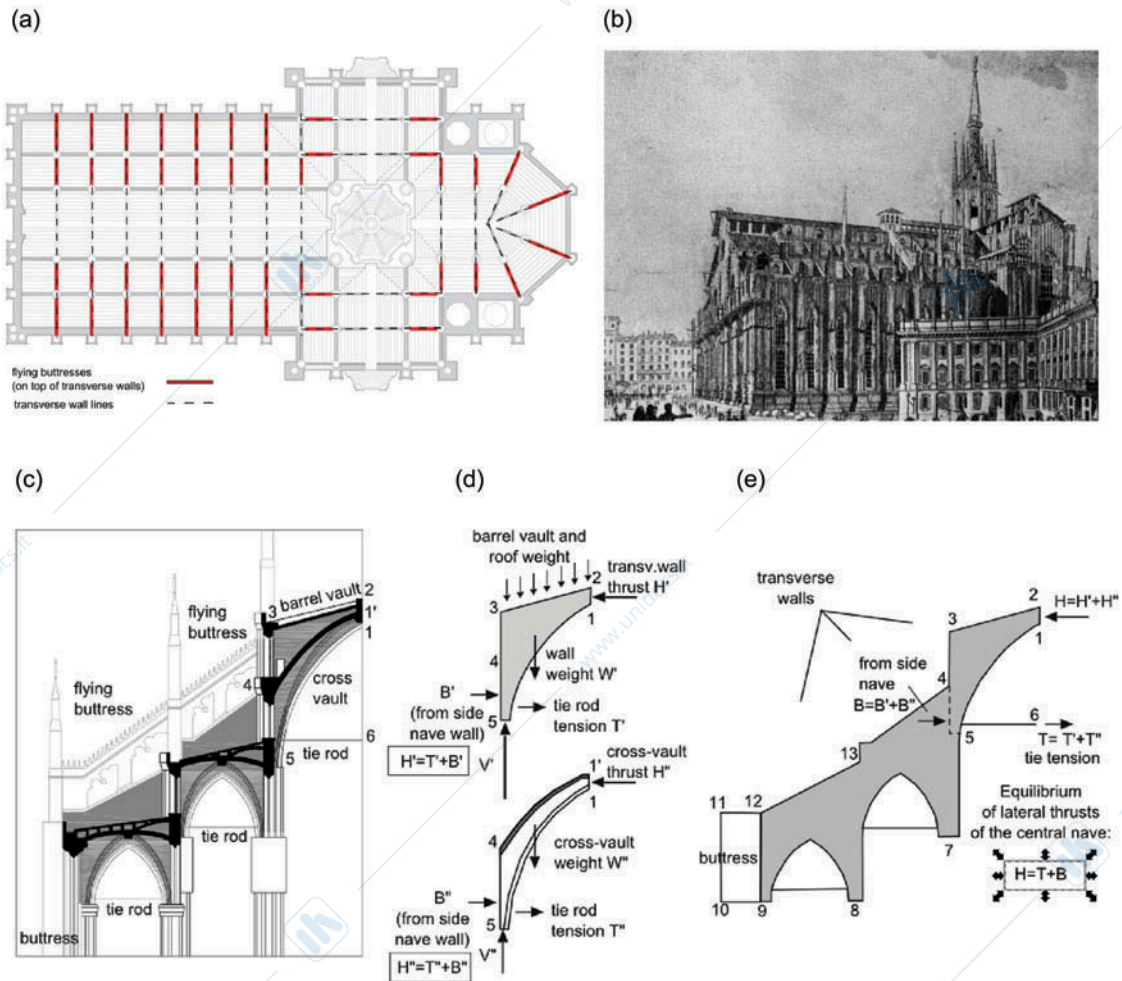

FIG. 6. Transverse walls and flying buttresses: (a) position in plan; (b) historical drawing by Gallari (1808); (c) configuration in the cross-section; (d) equilibrium of transverse walls with barrel vaults and cross vaults; (e) transverse walls and ties to balance the thrust of the central nave.

at each support are approximately $V' = 174$ ton and $H' = 64$ ton. These vertical and horizontal components sum up with those H'' and V'' of the cross vault system (points 1-1'-4-5 in Figure 6d). These latter forces in the scheme balance the cross-vault weight including arches, diagonal ribs and lateral filling.

The lateral thrusts H' and H'' are balanced in Figure 6d at the support (line 4-5) as the sum of the contributions from the transverse walls of the side aisles (respectively B' and B'') and tie rods (T' and T''). More in detail, B' and T' balance the thrust of the transverse walls of the central nave, due to the self weight of these walls and of the barrel vaults on top; B'' and T'' balance the thrust of the ribbed vaults, described as follows:

1. The transverse walls built on top of the arches of the lateral naves (Figure 6c-e, points 4-13) meet the higher adjoining nave in correspondence of the line of the piers (points 4-5), where the transverse walls and arches of the main nave and the vaults transfer their thrusts and vertical reactions. Hence these walls provide buttressing (forces B' and B''

in Figure 6d-e), with a load path in the inclined direction towards the lateral buttresses. The portion of these walls built above the roof was used posteriorly to support the flying buttresses (Figure 6c). These walls *de-facto* act together with the ties to provide the lateral buttressing of the construction. The use in medieval churches of diaphragm walls above the arches of the side aisle to provide buttressing of the central nave is described also by Fitchen (1961).

2. All arches had ties from the beginning of the construction, contributing to balance the lateral thrusts from the vaults (forces T' and T'' in Figure 6d). Ferrari da Passano (1988) stated that the effect of the vertical load increase from the barrel vaults reduced the tension or even eliminated the need of the ties. It must rather be concluded that the barrel vaults increase the lateral thrusts at the supports and hence the force in the ties with the contribution T' to the total tension T .

This underlines the importance of these tension members, in relation to the balancing of lateral thrusts in the construction.

The cross section of the ties is 45 by 75 mm for all arches, with the exception of the arches of the crossing with 55 by 95 mm ties. Metallurgical and mechanical properties are not yet available. It must be considered that the construction phases span over two centuries; hence different properties should be expected.

These issues have been here analyzed using a partly qualitative approach: in [Figure 6](#) the exact level of the line of action of forces B' and B'' is unknown; approximate quantitative calculations have been carried out only for forces H' and V' . Research is being developed at the Politecnico di Milano to study the problem analytically, modeling the three-dimensional structural action of the double vaults and estimating quantitatively the different contributions to the stability of the system.

The use of the ties as a permanent structural element is a particularity of the Cathedral, amongst other contemporary European cathedrals. The temporary use of ties made of timber or iron in the construction of Gothic cathedrals is widely commented by Fitchen (1961), together with a more spread use of iron fastenings in England with respect to France. In most cases these were removed once the structure was complete, with the full loads acting on the piers. The qualitative analysis in this section has shown that lateral thrusts from the vaults are resisted by these members, together with transverse diaphragm walls that transfer the outward forces to the lateral buttresses.

An essential part of the structural system of gothic Cathedrals are rib vaults, whose thrusts are resisted by flying buttresses (Heyman 1996). Another peculiar feature of the Cathedral is the system of double vaults: ribbed vaults in the interior and outer barrel vaults; the latter supporting a stone roof. As explained previously in this section, the thrusts are not taken by flying buttresses, but by the combination of diaphragm walls and steel ties. The flying buttresses and heavy pinnacles that can be seen today were added late in its history in the 19th century, and are not necessary for the structural stability ([Figure 6b](#)). The double vaults can be found in Italian practice, in the baptistries of Cremona, Pavia and Florence (Ferrari da Passano 1988). This arrangement, shown in the cross-sections in [Figures 5](#) and [6](#), is related to the shape of the longitudinal compartments of the ribbed vaults. The web here has a strong curvature from the crown to the springing from the lateral walls above the nave arcade.

The shape of the vaults has an important consequence in admitting light to the interior of the cathedral. Many gothic cathedrals in the main nave clerestory have tall windows; the former arches, frequently stilted, with the crown reaching close to that of the vault, provide the space for the entrance of light, such an essential element of the gothic style characterized by "daring achievements of outstanding height and glass-walled wonder" (Fitchen 1961). In Milan we find only small windows in the wall above the lateral arches ([Figure 5](#)), because the web descends so low at the sides. A second line of windows opens in the lateral walls above the web of the ribbed vault, visible from the exterior of the cathedral, providing

light only to the hidden chambers between the ribbed and barrel vaults. Moreover, the lateral buttresses being enclosed in walls, the windows in the outer wall on the perimeter of the cathedral are tall but narrow. The west facade has no rose window, but again only small openings. Hence the main nave and high vault are scarcely illuminated. This is in contrast with the illumination of the apse, where the wide spacing of the piers and buttresses forms three grand windows with stained glass and tracery ([Figure 2b-c](#)); amongst the largest in Europe, designed by Nicholas de Bonaventure at the end of the 14th century, these windows are a source of light with a powerful aesthetic effect.

3. STRUCTURE AND CONSTRUCTION

This section describes the structural configuration according to the phases of the historical construction process. The description is complemented with limit analysis equilibrium models (Heyman 1995) set up in order to understand the load path in the structure (see also [Section 4](#)). A synthesis of the progress of the construction in time is shown in [Figure 1b](#). The pre-existing basilica of Santa Maria Maggiore was progressively dismantled as the construction proceeded, starting from the construction of the piers of the crossing of the Cathedral ([Figure 1a](#)). Historical drawings show that part of the facade of that building remaining created a closure to the first part of the nave built during the 15th century.

3.1. Apse and Choir

The construction started in this part of the building, proceeding from East to West. The geometry of the apse ([Figure 1a](#)) is a half octagon in plan. The center of the octagon corresponds to the crown of a half dome with triangular cells, and six interior piers supporting the half dome are placed along the perimeter. These members together with six vertical members on the outer perimeter, support five quadripartite vaults of trapezium shape in the deambulatory. The outer piers are built grouped together with the exterior buttresses. As already mentioned, the buttresses around the perimeter of the apse are more widely spaced than those of the naves; here the apse is closed by large decorated windows. The description of the structure of the vaults was provided in the previous section, because of the similar characteristics with those of the naves.

Other solutions in Europe show the apse surrounded by a circle of chapels, such as in Cologne, or Amiens, with closely spaced buttresses; the buttresses are placed radially in this part of the construction, and the cross section is quite deep, as can be seen in Notre Dame in Paris, Reims and innumerable other examples. In Milan the depth of the buttresses is rather limited, considering the height and span of the naves, as can be seen in the cross-section and plan of the construction. The already mentioned role of the ties is evidently particularly important to the stability of this part of the building.

The sacristies on either side separate the choir by continuous walls running east to west (Figure 1a); another wall runs north-south on one side of each sacristy. The other two sides of the sacristies are connected to the buttresses on the exterior perimeter of the church. These walls and buttresses constitute a rather stout structural system with lateral load bearing capacity.

The structure of the transepts (Figure 1) is very similar to that of the longitudinal body, though with only three naves. One distinctive feature are the windows opening on the North and South facades at the level of the top half of the construction, similar in size to those of the apse.

3.2. Tiburio and Dome

The construction of the tiburio began with foundations and piers slightly larger than those of the other vertical members. At the beginning of the 15th century these were in place, with the pointed arches supported on them, together with the already built apse and choir, the transepts and the first bays of the naves. This configuration is important to determine the problem facing the builders at this point of the construction. Doubts arose on the fitness of the system to bear the tiburio to be constructed above, included in the design from the beginning of the construction.

More in detail, the construction had already reached the level of the base of the tiburio. The arches, the walls above the arches, the pendentives and the decorations were already in place in the crossing at the time before the dome was built (Ferrari da Passano 1988). At this stage, any intervention to strengthen or modify the construction had to take into consideration the opportunity or not of removing these elements.

The pointed arches for the tiburio had the same span as the other transverse arches of the nave. Ferrari da Passano (1988) reports that the total cross section depth is approximately 1.3 m and the width 1.05 m. The bottom and outer sides, visible externally are made of Candoglia whereas the inner part is made of brick, at the connection with the vaults of the naves, transepts and choir bearing on the arches. At the extrados, hidden internal iron ties run along the whole curve of the arches.

These arches were judged by the builders insufficient to bear the dome and spire. To deepen in this issue, Section 4 presents a calculation of the line of thrust in these arches, as if these had been the members bearing the construction that followed. The results confirm the intuition of the builders of the 15th century (Section 4.3). The discussion developed with foreign and Italian experts: Nexemberger from Graz, Filarete, Da Vinci, and Bramante, among others. The solution adopted was proposed by local personalities, first Giovanni Solari from 1452 and then Guiniforte Solari, who took the lead of the construction starting from 1459.

The solution by Guiniforte Solari consists of four semi-circular arches hidden behind the walls and pendentives (Figure 7a). The radius at the intrados is 8.6 m with the center of the circle at 7.5 m from the springing line of the pointed arches below. A relevant aspect of these arches is the great depth of

the cross section, ensuring a wide load path for the loads of the dome: at the crown 1.6 by 1.8 m, with the horizontal dimension being the largest. The material used is serizzo. The cross-section is obtained with voisoirs in radial position, in a ring of constant depth (1.6 m). Above this blocks are laid horizontally, reaching an extrados drawn by a circular line with a radius of nearly 18m and a center at the springing line of the pointed arches. Hence the typical representation of these arches in the drawings of the Veneranda Fabbrica del Duomo is that shown in Figure 7.

The elevation shows that these stilted arches are higher than the pointed arches (Figure 7a, front view). The arches in plan lie in an offset position (Figure 7a, plan view). The choice was made to build the arches supported on the piers of the crossing, without demolishing the walls above the pointed arches (Ferrari da Passano and Brivio 1967). The inner faces in plan—facing the crossing—correspond to a line just behind the existing walls above the pointed arches. The outer face—towards the nave, transepts and choir respectively—to another line that can be drawn in plan tangent to the external face of the piers. The axis of the arches in plan lies at 90 cm approximately from the line connecting the centroids of the piers. As a consequence the reactions of the arches on top of the piers are eccentric, as underlined by previous studies (Ferrari da Passano 1988).

This configuration caused very relevant problems to the construction after the striking of the centerings, because the pier tops moved outwards under the arch thrusts. The ties of the pointed arches below were all broken; two of these tension members fell to the ground, while the other two remained in place. The vaults surrounding the tiburio were damaged. The observation of these phenomena caused great concern, and the construction was stopped around year 1470.

The outward displacements measured during the 20th century restorations (Ferrari da Passano 1988) were approximately 10 cm for the four piers of the crossing and 5 cm for the other nearby piers. The two ties that had remained in place were found broken within the pier during the restoration works, with a gap of 14 cm between the two ends of the 95 by 55 mm cross-section; new ties were installed on all four sides in the restorations of the 20th century (Section 5). The nearby square vaults in the side naves and choir, placed along the diagonals of the crossing, were damaged with through-cracks in the courses of the cells and dislocations of the voisoirs of the diagonal arches reaching approximately 5–10 cm; these too were repaired in the 20th century. The rectangular vaults in the main nave, choir and transept on the sides of the crossing were not damaged.

With the decentering of arches, carried out progressively (Fitchen 1961), the members are loaded gradually. The development of the reactions at the supports inevitably causes lateral displacements (Heyman 1969; 1995; Como 2013) because of the horizontal thrust. The arch can be considered to accommodate itself to the increased span by cracking. Within a limit analysis model this corresponds to the formation of three hinges, providing a path for the thrust line from the extrados

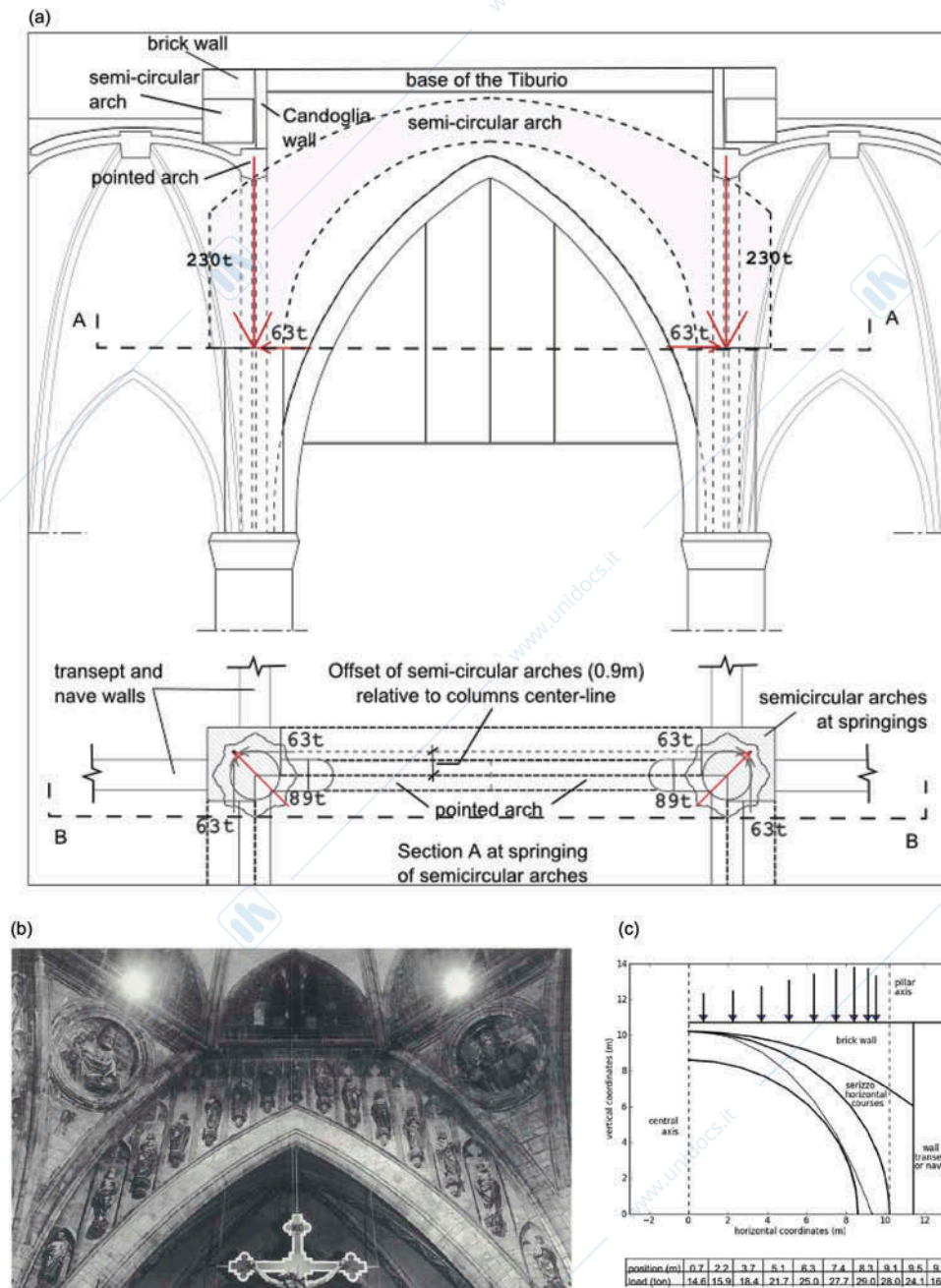

FIG. 7. Static effects of the construction of the round arches: (a) front and plan view of arches with values and position of the eccentric reactions; (b) view of the pointed arches and base of the Tiburio, interior; (c) line of minimum thrust for the loads acting in 1470 at the removal of the centerings.

at the crown to the intrados in a cross section close to the haunches. The lateral displacements of the supports of the arches in the Cathedral, due to the loading on decentering and the eccentricity of the reactions described above, indicate that the minimum thrust condition can be assumed; Figure 7c shows the calculation of the line of thrust for the loads acting at the moment of the decentering.

The point of application of the reactions is high above the pier tops. Observing the construction (Figure 7a), due to the

elevation of their position the arches laterally leaned against the walls built above the arches of the transepts, choir and nave, that transferred the thrust to the surrounding construction. Possibly the walls in the choir and sacristies, continuous on the whole height of the construction from the ground to the roof, played a role in the lateral stability (Figure 1), as also described in Section 3.1. As a matter of fact these parts of the construction and the lateral buttresses around the perimeter provided sufficient restraint, so that a collapse mechanism did not develop.

Despite the damage the structure reached a stable equilibrium that was the basis for the development of the construction.

After Solari's arches were built and the consequent damage occurred, discussions on the future developments and the building of the dome continued on to 1490. The decision was taken to proceed under the guidance of Amadeo and Dolcebuono, trusting the stability of the construction. Works for the dome were completed on September 24, 1500. Brick walls were erected above the semi-circular arches; above these the *tiburio*, described in the following, was built bearing on the semi-circular arches. The pointed arches below remained in place, bearing their own weight and that of the Candoglia walls supported on them, and hiding the semi-circular arches behind.

The dome (Figure 8) was built with the same characteristics of the existing construction – the half-dome of the apse in particular, with the same arches and vaults (Ferrari da Passano and Brivio 1967). The plan is octagonal, connected to the square of the crossing with pendentives. The dimensions are the same of the apse with a span of 32 braccia (19.2 m) and the crown at 19.2 m from that of the pointed arches of the crossing. The interior vaults are made of brick, with eight cells, and Candoglia marble ribs meeting in a central ring of brick and marble. The shape of each cell is triangular in plan; the curvature in the circumferential direction is broken by a central line starting at the crown of the pointed arches of the windows. Walls made of brick in vertical planes bear on the base and extend radially above each rib, creating a fan around the center where they connect at the central ring (Figure 8b). Barrel vaults span between adjacent radial walls at the top, to support the stone roof, and creating a chamber above the dome inner vaults. This is the same scheme used for the double vaults to support the roof above the naves.

The dome is enclosed within exterior vertical walls, along the perimeter of the octagon. Windows open at two levels, one looking into the interior of the church and the other into the chambers between the two vault systems. The walls connecting in the vertexes of the octagon form eight vertical members, with spires placed at their top. The weight of the walls sums with the forces transferred by the dome at the supports, bearing on the base of the *tiburio*. The outwards components of these forces are balanced by steel ties lying in the horizontal octagonal ring at the base of the dome. The vertical components are transferred by vertical walls onto the semi-circular arches of the crossing. Thus, following the history of the construction, the intensity and distribution of the loads on the semi-circular arches changed between years 1490 and 1500 with the construction of the *tiburio*, with increasing vertical forces and lateral thrusts on the underlying piers. However, further stages and changes were still to take place.

3.3. Main Spire and *Gugliotti*

The project to build a spire to crown the building dates back to the beginning of the construction (Ferrari da Passano

1988). Amadeo in the 16th century made a first attempt of the construction that was soon abandoned. The main spire, *la Gran Guglia*, was built in the 18th century. A very brief summary of part of the history of the construction is given here. The references provide further details (Brivio and Repishti 1998).

The final design (Figure 9) was presented by Francesco Croce in 1764. Its base is at the level of 65.6 m and reaches 104.9 m at the feet of the statue of the *Madonnina*. The spire is a rather light structure, with a central marble cylindrical tube, with eight piers on the outer perimeter. At three quarters of the height from the top (74.6 m from the ground), these become 16 vertical elements with a widening of the overall width of the spire. The outer piers are connected to the inner core by helical marble stairs, stiffening the structure. All the stone works are connected by a complicated system of iron ties, with longitudinal elements within the central void and transverse fastenings. The total weight is nearly 300 tons for the part above 74.6 m. The total weight bearing on the top of the *tiburio* is 884 tons (Figure 9).

The issue of the structural safety with the building of the spire was the object of studies amongst some of the most relevant scholars of the time, the Jesuit Ruggero Boscovich of the university of Pavia and the Barnabite Francesco De Regi in Milan. The questions posed regarded both the stability of the spire itself and the stability of the building as a whole under the new load. De Regi reasoned on the basis of the theory by Belidor (1729), whereas Boscovich used a model with the development of hinges in a collapse mechanisms. Both concluded that the building of the spire was safe. A review of these studies is provided by Brivio et al. (2003). The construction was concluded in 1767 according to the project by Croce.

The four *gugliotti* (Figure 10) are small towers with spires at the top, placed on the roof at the four corners of the square corresponding to the perimeter of the crossing. The first was built between 1507 and 1518 by Amadeo above the north-east pier and the others followed much later in the second half of the 19th century, named after their builders: Pestagalli (1844–1847); Vandoni (1892); Cesa Bianchi (1887–1890). Their position corresponds to the piers of the crossing, and their load flows directly onto these members. The weight of each *gugliotto* is reported in Figure 10. The overall axial force of each pier increases with the weight of the corresponding *gugliotto*. The contribution of 100–150 tons given by each is less than 5% of the total axial load, approximately equal to 3000 tons at the base of each pier. Nevertheless significant damage showed in these vertical members with cracking of the outer Candoglia ring. Historical reports show that this led to the closing of the Cathedral at the end of the 19th century for restoration works. The event is highly important, showing that these members were already close to their safety limit at the time.

At the end of this description the question arises as to which are the visible signs today of the different phases of this

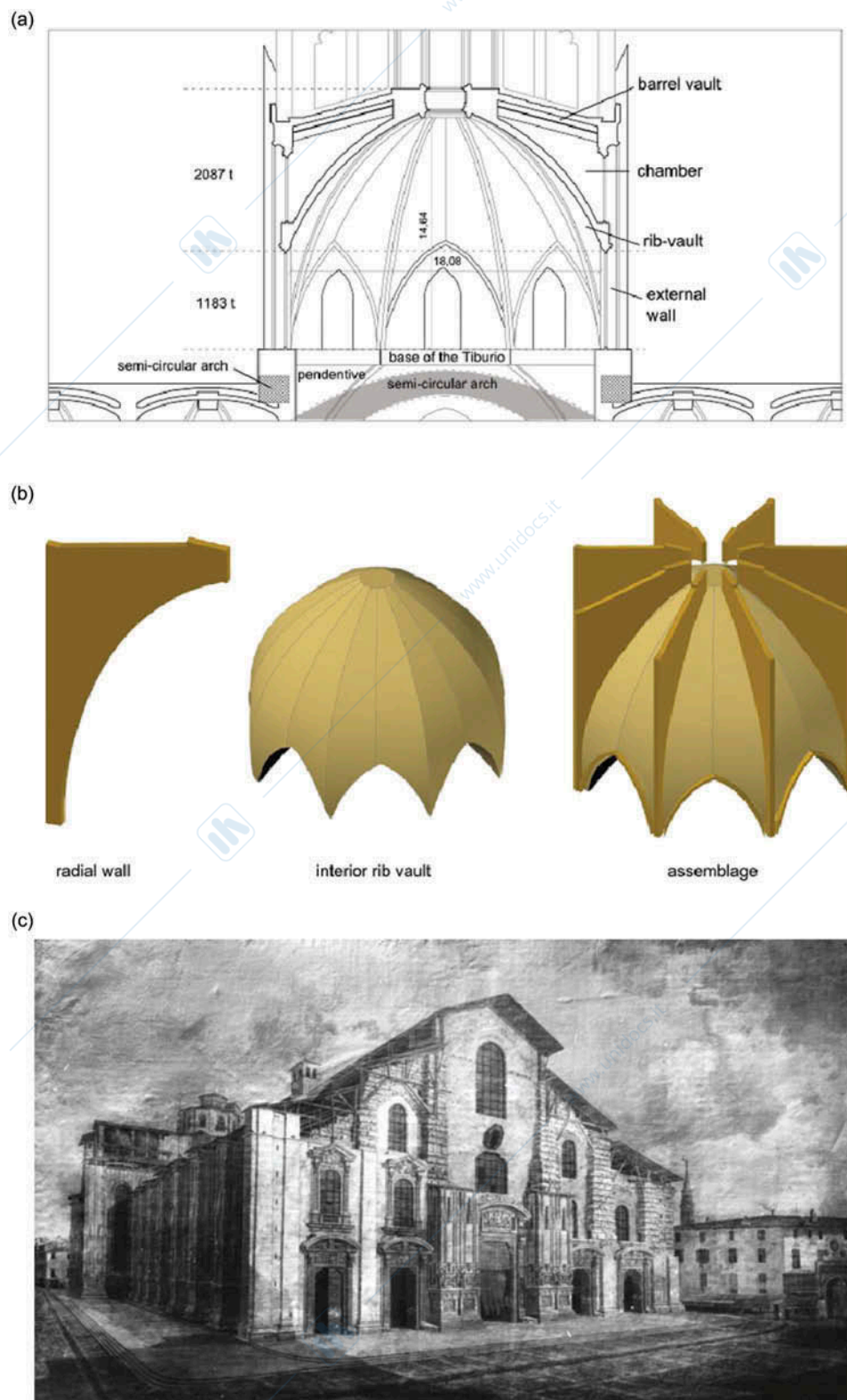

FIG. 8. Tiburio: (a) geometry and weights of the lower and upper part (divided by horizontal broken lines); (b) three-dimensional representation of radial walls and interior vaults; (c) historical drawing by Dal Re (1735).

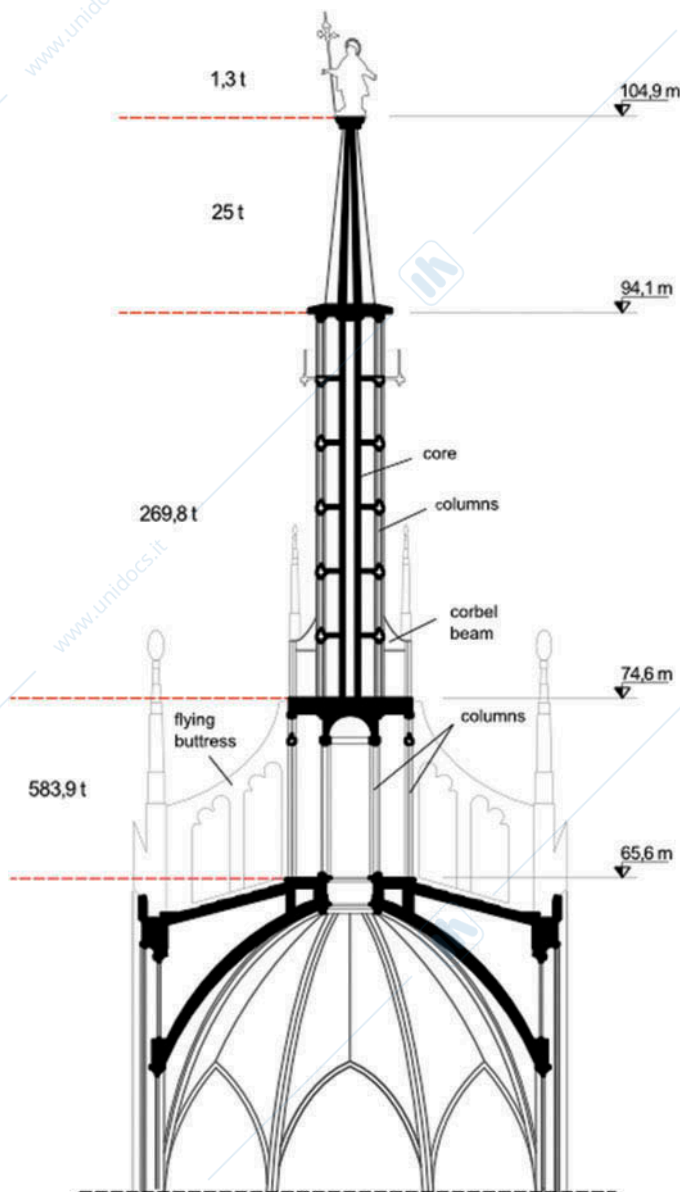

FIG. 9. Main spire geometry and weights of parts (divided by horizontal broken lines).

long evolution. For the construction phases, the records of the Veneranda Fabbrica del Duomo (Ferrari da Passano 1988) show that all parts were built respecting the same configuration of the vaults, proportions of spans, dimensions of members. Only slight geometrical differences can be noted, within the tolerances of the construction methods used. As already mentioned the exterior appearance of the construction was finished in the 18th and 19th century, with the building of the facade, flying buttresses and spires; these works contribute to the unitary features of the cathedral. For the accumulation of damage and repair, see section 5.

4. ANALYSIS OF THE LOAD PATH

The aim of this section is to show the role of the different parts of the Cathedral in providing a stable configuration in the structure at the end of the construction, using static limit analysis. The assumptions of the theory (Heyman 1995) are that of unlimited compression strength of masonry, no tensile strength and no sliding failure occurring. These are the basis of the application of the lower-bound limit theorem of plasticity: the structure is stable, if a thrust line can be determined, in equilibrium with the external loads, lying within the boundaries of the masonry. The load applied is a lower bound of the load causing collapse. The loads were provided by detailed geometrical measurements and drawings made during the restoration works of the main piers at the end of the 20th century (Ferrari da Passano 1988), provided by the archive of the Veneranda Fabbrica del Duomo.

4.1. Main Spire

This section and the following analyze the effect of the construction of the spire on the underlying structures. As already mentioned the problem was studied by Boscovich and De Regi before the construction of the spire in the 18th century. It is interesting to report that these scholars did not consider the presence of the semi-circular arches, due to a lack of information on the construction. Their analyses proceeded with the methods developed at their time, concluding that the structure would be absolutely safe with the new load increase. Modern theory, as will be tentatively shown in Section 4.3, indicates that their conclusions—given the members they considered—were not correct (Corradi dell'Acqua 2013).

The self-weight of the spire is taken into consideration here, to determine the forces transferred on the tiburio. The effects of wind loading have been studied by Calvi et al. (2012) by elastic three-dimensional finite element analysis, in relation to the restoration works of the spire. Recent seismic events in Italy have lead to a dynamic identification study by means of experimental measurements and a numerical model (Giorgetti and Postoli 2012).

As already mentioned the structure of the spire is composed of an inner cylinder and eight outer piers on an octagonal base (Figure 9), above the level of 74.6 m. At this level the scheme changes partially, in correspondence of a horizontal terrace. A few meters above, horizontal corbel beams widen the width of the structure, and, below these beams, the outer piers double in two vertical elements at each vertex of the octagon; thus the whole structure is stiffened. Hence these vertical elements transfer 16 reaction forces on the crown of the dome, arranged in two circles, one at the inner and the other at the outer radius of the ring, with a distance of approximately 2 m. This influences the load path in the underlying dome. To determine the equilibrium force distribution at the base of the spire the weight is simply divided into 16 equal forces—equal reactions in the inner and outer ring of supports.

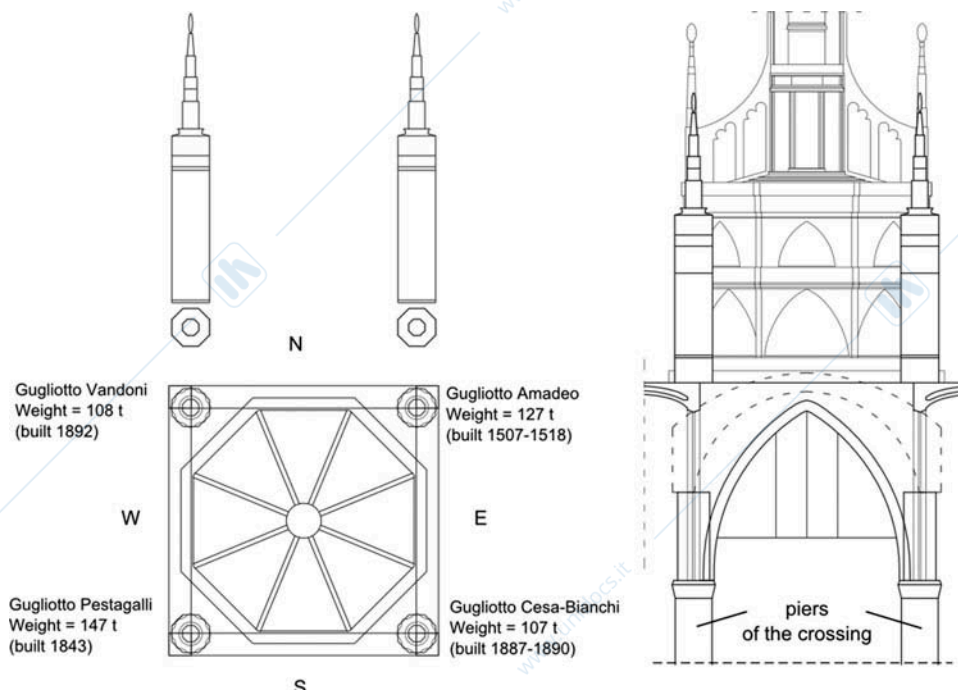

FIG. 10. Position of the *gugliotti*, weight, load transfer onto the piers of the tiburio.

The flying buttresses, concave upwards, are connected at the spire in correspondence of the floor at 74.6 m giving the pyramidal shape to the base of the spire, and extend radially on the whole width of the roof of the tiburio. For gravity loading, it is assumed that these members simply transfer their self-weight as simply supported members with that of the vertical supporting piers to the tiburio beneath.

The results of these assumptions on the loads transferred from the spire to the tiburio are shown in the following section. With the construction of the spire in 1765 the load was distributed by the structure of the tiburio on its eight supports, bearing on the semi-circular arches below. The construction of the spire did not provoke evident damage to the piers of the tiburio beneath. The *gugliotti* added posteriorly between 1844 and 1890 (Section 3.3) triggered the first signs of distress in the columns. It appears clearly (Figure 9 and 10) that both the loads of the main spire and the *gugliotti* summed up on the piers of the crossing causing the structural problems that followed; the *gugliotti* added posteriorly were the last load increment.

The load increase due to the spire at a first examination would result equal to 300 tons, the weight of the part of construction above 75 m; the part between 64m and 75 was built with the tiburio. However historical drawings (Figure 8c) show that before the spire was built this latter part of the tiburio did not include the flying buttresses and several other decorative members added posteriorly at the end of the 18th and throughout the 19th century, that are a significant part (approximately 350 tons) of the 583 tons weight of this part. Hence the load increase with the main spire was close to 650 tons.

4.2. Tiburio and Dome

The load bearing mechanism is analyzed by a combination of two load paths, one in the ribbed vaults of the dome and the other within the radial brick walls (Figure 8 shows the geometry).

The radial brick walls support the barrel vaults at the top (Figure 8b), the roof and the main spire with the flying buttresses. Moving from the interior to the exterior the load distribution on each of the walls (Figure 11a) includes two forces at 2.0 m distance for the weight of the spire; the weight of the brick barrel vaults with 0.4 m thickness, the stone floor of the roof, the flying buttresses, and the self-weight of the walls. At the outer end, at the base of the dome, the last contribution is the weight of the vertical walls enclosing the eight sides of the tiburio, with one spire on the top of each.

Regarding the interior vaults, the ribs are visible on the interior surface of the dome (Figure 8a). The rib cross section has the same shape of those of the vaults of the naves, with a depth of approximately 0.5 m. The dome vaults (Figure 8b) are made of brick with 0,4m thickness in the top part, from the ring at the top to the crown of the window arches, at 6.5 m from the base of the tiburio; close to the supports the volume between the outer wall of the tiburio and the inner vault is filled with brick. The load path is analyzed by equilibrium of meridian and circumferential forces balancing the gravity loads (Huerta 2003; Como 2013) for a portion of one eighth of the vault, from the crown of the dome to the level of the crown of windows. This model is used, as recent surveys carried out by the Veneranda Fabbrica del Duomo did not highlight any cracking. It is assumed that

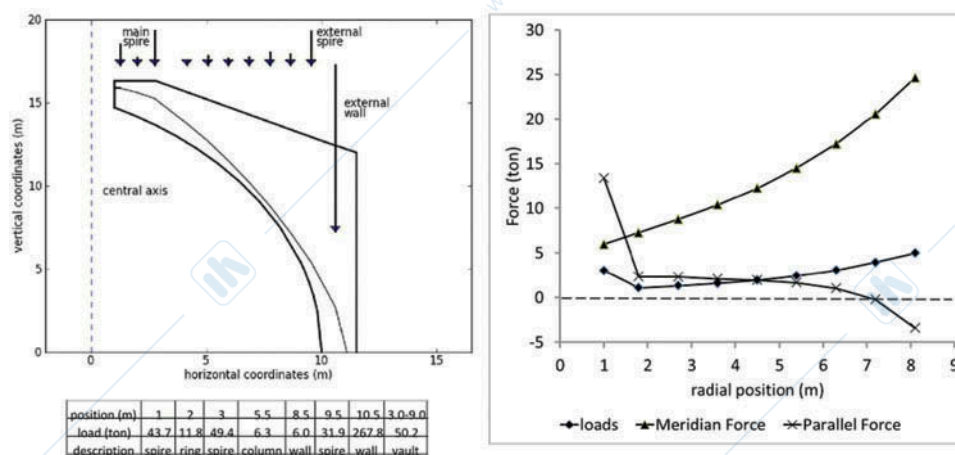

FIG. 11. Dome: (a) loads and thrust lines for the radial walls and (b) loads and membrane forces of the interior vaults.

the weight of the marble ring at the crown is carried by this system (Figure 8). Results are shown in Figure 11b; the circumferential forces pass from tension to compression at a level corresponding approximately to the crown of the windows. Here the builders placed circumferential iron tension ties. It is interesting to note that for this part of the construction it was also possible to find an equilibrium solution with radial arches, under the classical hypothesis for limit analysis of masonry of no-tension resistant material (Heyman 1967).

The reactions of the radial walls and the interior vaults are summed at the base. All forces concentrate at the eight support points of the tiburio, providing steeply inclined thrusts on the roof, above the four main round arches. The sum of the reactions at the base for each of the eight support points gives a vertical force of 518 tons and a horizontal thrust of 156 tons. The vertical components bear on the main semi-circular arches, with the transfer of two forces of 518 tons for each arch (Figure 12).

4.3. Arches Supporting the Tiburio

The calculation of the line of thrust within the main semi-circular arches supporting the Tiburio is shown in Figure 12a, considering the loads of the final configuration after the building of the main spire. The forces from the dome are transferred onto each arch in two points, over a rather short length; each support of the tiburio transfers a load of 518 tons over a length of approximately 3m. At these locations the base of the tiburio is very close to the extrados of the arch. The other relevant contributions to the loads are the self-weight of the arches and of the brick walls built on top, reaching up to the base of the dome. The Candoglia walls in front of the semi-circular arches are supported by the pointed arches below.

The compression line is determined according to the minimum thrust assumption (Heyman 1969). It must be remarked that the system probably evolved towards this configuration due to the horizontal displacements at the springings that took place after the construction of the arches, described in Section 3.3.

The compression resultant is within the cross section of the arch. Rather sharp changes in slope take place at the location where the forces from the tiburio load the arch. The horizontal thrust for the scheme shown in Figure 12a is 370 tons and the vertical reactions at the springings 756 tons. It is evident that the shape of this compression line can be accommodated within the arches owing to the depth of the cross-section and the shape of these members. As mentioned in section 3.2 the ties connecting the four piers of the tiburio broke with the decentering of the arches, hence these lateral thrusts were balanced by the construction surrounding the tiburio.

A simulation of the line of thrust in the pointed arches is shown in Figure 12b, assuming that they would have been used as members to support the tiburio. These arches were judged by the builders insufficient to bear the dome and spire. The loads corresponding to the final configuration after the building of the tiburio and spire is considered. Due to the limited diffusion of loads in a masonry wall (Giuffrè 1990; Como 2013) a load distribution corresponding to the width of the supports of the tiburio is considered. The possible lines of thrust all lie partly outside the arch, showing that an equilibrium condition is impossible (Heyman 1995; Romano and Ochsendorf 2010); a set of three thrust lines is shown in Figure 12b, as an example. These inverted funicular curves are strongly influenced by the position and intensity of the large reaction forces of the Tiburio. The difference between the geometry of the arch and the thrust lines corresponding to the load distribution is such that no stable configuration is possible. This indicates critical conditions and confirms the intuition of the builders of the 15th century (Section 3.2).

4.4. Loads on Piers and Foundations

The loads on the piers of the crossing are estimated on the basis of the forces transferred by the semi-circular arches, the weight of the piers capital and shaft, the pointed arches with the

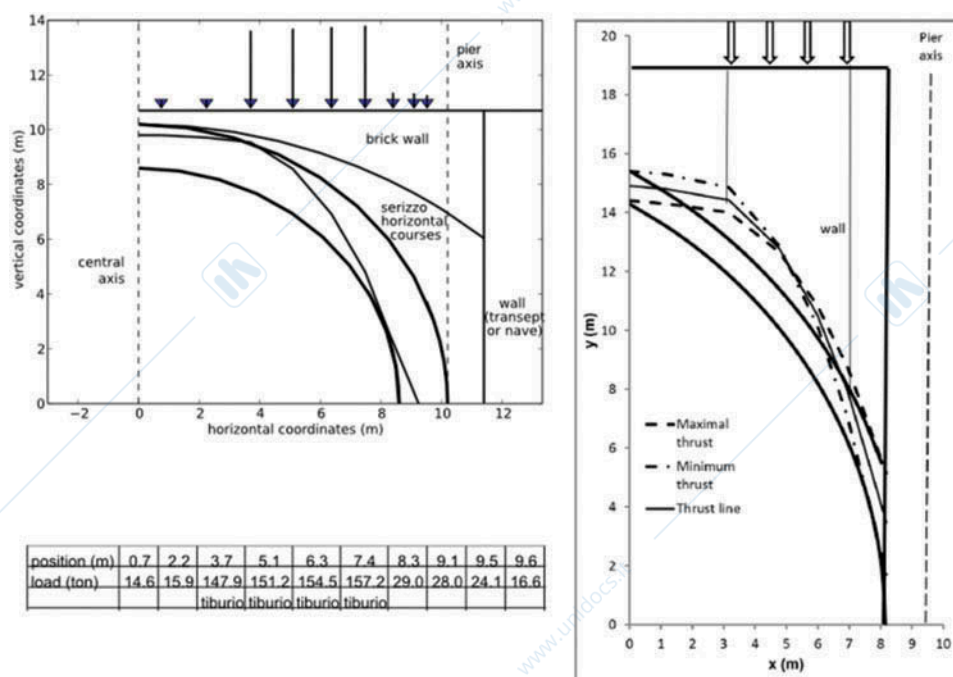

FIG. 12. (a) Semi-circular arches of the crossing supporting the tiburio: loads and line of thrust; (b) Simulation of the line of thrust in the pointed arches supporting the tiburio.

walls above them and the pendentives of the tiburio. In addition the loads from the vaults of the transept and nave, and from the longitudinal and transverse arches must be added. Finally also the weight of the gugliotti must be considered. The total is approximately 3500 tons without the foundations, and 4200 tons at the base of the foundation. These forces are much larger than those of other piers in different positions: approximately 2050 tons and 1650 tons for the piers of the main nave and those of the lateral naves, without the foundations. The calculation of the load transfer for these latter members is based on tributary areas, considering the weight of all the structural members and other parts of the construction within each portion of the building.

Forces at the base of the foundations of the main piers have been calculated in the different phases of the history (Figure 13a). This diagram shows that the most important load on these members was the construction of the tiburio. It can be stated that already at the construction of the tiburio around year 1500 the safety margin was relatively low, considered that these members were bearing nearly 3000 tons and showed significant damage at 3500 tons. Nominal stresses under the foundations of piers in different positions of the plan have been calculated, assuming square foundations with a dimension of 7 m (Figure 13b).

4.5. Complements for Future Studies

The preliminary analyses in this study, based on limit analysis, show the role of the different parts of the Cathedral

providing a stable structural configuration in the structure. More refined finite element models could provide a detailed description of the geometry, the morphology of the members and the material behavior (Roca et al. 2010). In this respect one problem needing deeper study is the combined action of the tension ties and lateral buttresses balancing the lateral thrusts of the vaults. This is a peculiar aspect of the Cathedral, related also to the original features of the double vaults. The preliminary analysis presented in Section 2.3 should be complemented with numerical analysis to achieve a more complete understanding of the structural action with quantitative results. Technically this would provide useful information for decisions related to the restoration of the members in this part of the load bearing system.

The analysis of the semi-circular arches supporting the tiburio (Sections 3.2 and 4.3) shows the action of these members. A three-dimensional numerical model of the portion of the structure including these members, the tiburio, the supporting piers, with the surrounding vaults and buttresses could explain in depth the mechanism, described qualitatively in Section 3, by which the lateral thrusts were balanced, given that the ties broke on the decentering of these arches. As these members were loaded by the weight of the tiburio and spire in different moments of the history also sequential analyses would be of interest (Roca et al. 2013).

The piers supporting the tiburio and the other nearby vertical members were damaged in all these phases of the loading history; the evaluation of the progressive damage accumulation would be useful to interpret the phenomena occurring in the

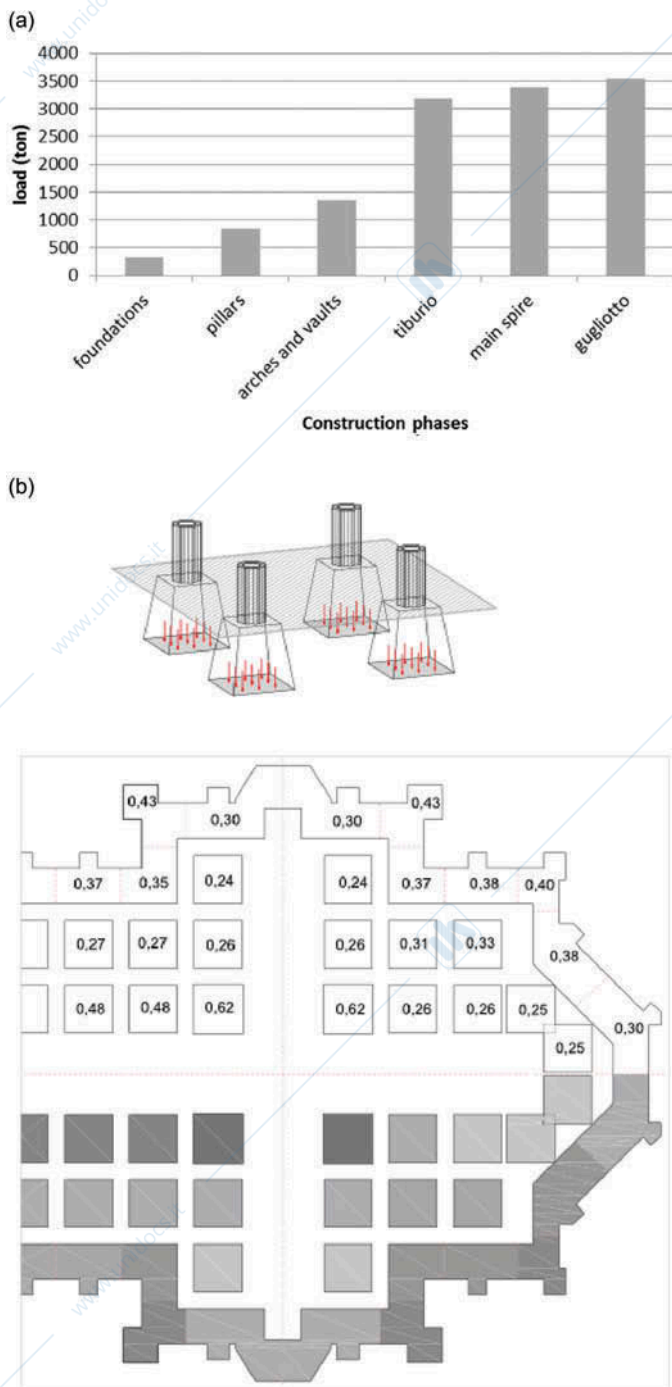

FIG. 13. Foundations: (a) evolution of loads in time under the main piers (level -7m); (b) pressure (MPa) under the foundations (7 m × 7 m) of the piers in different positions in the final state (shades of gray indicate intensity qualitatively).

19th and 20th century (Section 5). Limit analysis is based on the assumption that the stresses in the masonry are low with respect to the strength of the material. This is not true for those members that showed signs of distress after the construction of the

gugliotti at the end of the 19th century and with the ground subsidence in the 20th century. The possibility of complementary analyses for this part of the structure is discussed in the following Section 5, after describing the damage and restoration that occurred in the 20th century.

5. STRUCTURAL RESTORATION WORKS

To complete the analysis a short summary is presented of the main structural restoration works that took place in the period ranging from the end of the 19th century until today. These have been the object of detailed reports (Ferrari da Passano and Brivio 1967; Ferrari da Passano 1988).

The size of the cross-section, and the type and quality of construction were at the origin of the distress in the piers of the crossing, as discussed in Section 2. The building of the tiburio added high loads on these members; the configuration of the supporting semi-circular arches caused eccentricity of these loads and lateral displacements of the pier. The spire in the 18th century further increased the loads.

In the second half of the 19th century, the piers of the crossing were damaged by the construction of three of the four gugliotti, as mentioned in Section 3. This indicates that the load was such to leave a low safety margin for these members. Restorations were carried out extracting the damaged parts and substituting with lead the inner voids, then covering by marble.

The new event taking place in the 20th century was the lowering of the water table caused by industries consuming the water around Milano and right into central parts of the city. Measurements showed a 25 m decrease since year 1900, of which 20 m taking place since 1950. The increased stresses in the soil without the water pressure provoked settlements of the foundations. Measurements showed that the southern part of the crossing was sinking with respect to the surrounding structure; relative displacements over an interval of 5 years (1966–1970) were of 1.75 mm between two piers of the crossing, 5.5 mm between piers at opposite ends of the transept, 20 mm of a pier of the crossing with respect to the west end of the nave (Ferrari da Passano 1988).

Observations of the piers in the crossing and also in the choir showed cracks in the blocks of the outer Candoglia skin, with an approximately vertical orientation. Monitoring showed that the crack widths were increasing in time and the formation of new cracks. Eventually some parts of the outer marble blocks spalled and fell to the ground.

A working group was formed in 1965 by the Veneranda Fabbrica del Duomo and the Politecnico di Milano conducted by Professor Piero Locatelli. The piers of the crossing were provisionally encased in reinforced concrete, while those of the choir with a steel structure. The possibility of the load bearing capacity of the foundations having been overcome was excluded, based on geotechnical verifications. The effect of vibrations caused by the passage of underground trains close to the northern side of the cathedral was studied by Bruschi

et al. (1987) but resolved that these were not relevant for the phenomena under observation. Analysis of the damage occurring was carried out using an experimental model of the whole Tiburio (scale 1:15) with the surrounding vaults and supporting vertical members (Ferrari da Passano and Oberti 1983). The damage phenomena were explained as caused by the foundation settlements, causing a redistribution of forces within the structure and consequent overloading of some piers with respect to others (Ferrari da Passano 1988). The local authorities banned the use of water from wells surrounding the central part of Milan, hence stopping the lowering of the water table. This in turn gradually stopped the ground settlements.

Models of the piers (scale 1:4.7) were built and tested, in order to study the effect of different restoration and strengthening techniques (Ferrari da Passano and Oberti 1983). The final solution adopted for the four main piers of the crossing, proposed by the architect of the Veneranda Fabbrica del Duomo, Carlo Ferrari da Passano, was that of removing progressively the reinforced concrete skin and replacing parts of the damaged outer ring of marble with new pieces of the same material and shape, though penetrating deeper in to the inner core of the pier and providing an increased load-bearing capacity. The final state corresponds to the same construction and materials of the original construction. The four piers supporting the tiburio appear sound, practically free from visible damage and more aesthetic because of the cleaning related to the repair operations. The permanent lateral displacements at the top of these members, caused by the construction of the semi-circular arches of the tiburio, can still be measured. Approximately 20 piers—excluding the four members of the crossing—show a visible intervention with repointing mortar, filling also some cracks and spalling in the stone.

Another intervention was the placing of steel tension ties connecting the four piers of the crossing, at the level of the ancient ties broken in 1470, and anchored within the walls of the transepts. Similar ties were installed running longitudinally along the nave, at the level of the clerestory. Finally, displacement monitoring on relevant points of the building began, and has been carried out with a period of six months up to today.

Another long series of restoration works still in progress concerns the exterior of the cathedral, carried out throughout the last three decades to defend the surface of the Candoglia stone and the details of the artistic sculptures, decorating the edifice, from biological and chemo-physical attack (Toniolo et al. 2006).

Further on-going restoration activity concerns the main spire. This part of the building has suffered in time corrosion problems of the iron work of its structure. A part of the horizontal floors collapsed in 1842. After taking into consideration the dismantling, a conservative restoration was carried out. Other deteriorated iron parts were replaced with stainless steel around 1970. The Candoglia marble though was damaged as a consequence of the expansion of the corrosion products. Hence the new millennium started with a restoration project in order to replace all damaged parts up to the non accessible zones reaching the top

at the feet of the Madonnina. This required installing metallic scaffolding all around the main spire, anchored to the roof of the tiburio and designed in order to limit wind induced vibrations, thus avoiding damage to the spire because of hammering (Calvi et al. 2003). Presently the work is in its final phases. As an offspring of these activities, in order to monitor the effects of the 90 tons of scaffolding erected for the repairs, monitoring of displacements, accelerations and strains in the dome and spire has started, and will continue after the termination of repairs (Cigada et al. 2011).

The conditions of the piers was successfully improved by the restoration works described in this section; these members have been now in service for more than 30 years. Explanation of these past phenomena though was only partial. The experimental scaled model (Ferrari da Passano and Oberti 1983) being elastic, made of materials obtained with epoxy resins, lead to estimates of the redistribution of loads with the ground settlements. These events could be examined and understood more deeply by numerical analysis with nonlinear constitutive models for the materials, including long term effects (Binda 2008). The effect of soil settlements evolution in time should be included. Thus a more thorough explanation of the phenomena nearly leading to the collapse of the tiburio could be reached, and the present and future evolutions followed.

It is possible that other parts of the structure experience critical overloading conditions that should be the object of similar analyses considering the nonlinear behavior of materials. For instance several damaged voisoirs in the arches and ribs of the lateral vaults were replaced out in the years 1990–2000; a possible cause could be the soil settlements, but no in-depth study has been carried out.

Limit analysis indicates a safe static solution for the semi-circular arches supporting the Tiburio. Being hidden for most of their geometry, some questions can be put regarding their state of conservation, starting from the possible cracking initiated on the striking of the centerings and throughout the life of the construction. Monitoring and in-depth analysis including damage and long-term effects are necessary for these members supporting together with the four piers of the crossing the most important and delicate part of the cathedral.

Studies on the effect of lateral loads in the spire have also been started during the more recent restoration works. An elastic three-dimensional finite element model was used to predict the response with the building of the scaffolding around the main spire, anchored to the roof of the tiburio. The damage in the spire is due to environmental actions with iron corrosion combining with load effects to damage the stone work. These phenomena highlight the need to consider durability issues and coupled mechanical and chemo-physical phenomena in future analyses (Coronelli et al. 2013; Zandi et al. 2011). At present, substitution of both stone and metallic parts in the spire with new Candoglia and more durable metallic elements is being undertaken. These operations, as was done for the scaffold erection phases described above, would benefit of

numerical analyses providing more detailed knowledge of the state of stress during temporary removal of parts; in addition the possible need of strengthening could be studied.

6. CONCLUSIONS

The structure of the Cathedral of Milan has been described and analyzed, following its historical development through the different construction and restoration phases. The study starts by analyzing the global layout and the main parts and elements, on the basis of their geometry and structural action. The progressive development of the structural system has been followed through its historical phases: from the foundations to the piers and vaults, then the building of the tiburio and dome, and finally the main spire and gugliotti. The final configuration reached is then analyzed with its main load paths. The main structural restoration works taking place during the life of the structure of the Cathedral have been outlined.

The method is that of a qualitative description of the structural action, accompanied and corroborated by preliminary analysis. The former is based on existing studies and develops some partly new interpretations. The latter is accomplished by limit analysis models based on equilibrium first principles, resulting in a simple but accurate synthesis of the load paths in the building. On the basis of static limit analysis the role of the different parts of the Cathedral providing a stable structural configuration has been shown.

The initial layout chosen by the builders has been described, highlighting the scarcely sufficient sizing of a part of the structures, namely the piers of the crossing and the arches supported on these. These shortcomings were partly recognized during the construction: the correct decision not to rely on the pointed arches in the crossing, taken by Guiniforte Solari in the late 15th century, has been demonstrated here by evaluating the possible failure mechanism. The solution of constructing hidden semi-circular arches to support the tiburio and main spire has been analyzed. Its deficiencies have been highlighted, causing damage in the piers below the arches and the vaults around the crossing. At the same time, the analytical models have confirmed the validity of the system to bear the loads, proved by the existing construction. The load bearing mechanism of the tiburio and dome supporting the main spire have been described, and a simplified scheme for load paths has been proposed.

Several features of the building with the original aspects of its load bearing system have been discussed; amongst these are the double vaults of the main nave, namely inner quadripartite vaults and outer barrel vaults. The influence of the weight of the latter barrel vaults in the load path onto the vertical supporting structures has been analyzed. The role of the tension ties provided to all longitudinal and transverse arches has been highlighted. Another related issue is the role of the walls built above the transverse arches. These were included in the construction from its beginning, providing buttressing for the lateral thrusts

from the naves. Finally, the structural history of the main vertical members has been outlined, starting from the choice of pier cross-sections in the crossing and the nave, the damage accumulated throughout the different events and the 20th-century restoration.

The analyses presented herein develop the knowledge for further historical studies encompassing structural, construction and architectural issues. The results provide a reference for restoration interventions and a basis for the verification of more detailed numerical analyses. The aim was that of providing a relatively simple but clear interpretation of the global structural response with its evolution throughout the life of the Cathedral. Future developments have been outlined in the paper, aiming to address in detail each part of the construction and the different phases of its life and restoration. One example is the current developments of this research, regarding the in-depth study of the statics of the vaults of the Cathedral.

ACKNOWLEDGEMENTS

The Authors are grateful to the Veneranda Fabbrica del Duomo and the Architect Ing. Benigno Mörlin Visconti Castiglione for the information provided on the geometry and loads, the on-site observations with Geom. Francesco Aquilano and the technical team of the Fabbrica, and for help in the archive researches. The inspiration for this work was triggered by Professor Leone Corradi dell'Acqua, member of the Commission for the Structural Safety of the Duomo at Politecnico di Milano. Discussions with Professor Guido Mangano (†) and Professor Marco Locatelli are acknowledged. The authors are thankful for advice and assistance by Professor Federico Perotti and Professor Carlo Poggi, members of the Commission for the Structural Safety of the Duomo at Politecnico di Milano.

REFERENCES

- Ackerman, J. S. 1949. *Ars sine scientia nihil est: Gothic theory of architecture at the cathedral of Milan*. *Art Bulletin* 31:84–111.
- Belidor, B. F. 1729. *La science des ingenieurs dans la conduite des travaux de fortification et d'architecture civile*. Paris, France: Claude Jombert.
- Beltrami, L. 1881–1914 [1964]. *Luca Beltrami e il Duomo di Milano: Tutti gli scritti riguardanti la cattedrale pubblicati tra il 1881 e il 1914—Raccolti ed ordinati a cura di Antonio Cassi Ramelli*. Milan, Italy: Ceschina.
- Binda, L. 2008. *Learning from failure. Long-term behaviour of heavy masonry structures*. Ashurst, UK: WIT Press.
- Bradford Smith, E. 1997. *Ars mechanica: Gothic structure in Italy*. In *The engineering of medieval cathedrals*, vol. 1, ed., L. Courtenay, 219–234. Farnham Surrey, UK: Ashgate.
- Brivio, E., F. Repishti, and A. Cura. 2003. . . e il Duomo toccò il cielo: I disegni per il completamento della facciata e l'invenzione della guglia maggiore tra conformità al gotico e razionalismo matematico. [. . . and the Duomo touched the sky: the drawings for the completion of the façade and the invention of the main spire between conformity to the gothic and mathematical rationalism]. Milan, Italy: Skira Editore.
- Bruschieri, G., L. Mazzon, and M. Santini. 1987. Intervention by Milan Transport Corporation to safeguard cathedral structures against vibrations transmitted from the subway. *Ingegneria Ferroviaria* 42(4):156–168.

- Calvi, G. M., M. Moratti, R. Nascimbene, E. Fagà, and R. Pinho. 2003. La Gran Guglia del Duomo di Milano: Analisi, modellazione e verifica. *Structural Modeling* III(7):4–6.
- Cigada, A., L. Comolli, A. Giussani, F. Roncoroni, and F. Zenucchi. 2011. Thermal characterization of FBG strain gauges for the monitoring of the cupola of Duomo di Milano. In *Proceedings of SPIE: International Society for Optical Engineering, 21st International Conference on Optical Fiber Sensors*, vol. 7753, article number 775380, Ottawa, Ontario, Canada. Bellingham WA: SPIE.
- Como, M. 2013. *Statics of historic masonry constructions*, vol. 1. Springer Series in Solid and Structural Mechanics. Milan, Italy: Springer Verlag.
- Coronelli, D., K. Z. Hanjari, and K. Lundgren. 2013. Severely corroded RC with cover cracking. *ASCE Journal of Structural Engineering* 139(2):221–232.
- Corradi dell'Acqua L. 2013. Boscovich as an engineer: The statics of masonry domes. *Memorie Società Astrofisica Italiana* 22(suppl):83.
- Courtenay L. T. 1997. *The engineering of medieval cathedrals*. Farnham Surrey, UK: Ashgate.
- Ferrari da Passano C., and E. Brivio. 1967. Contributo allo studio del Tiburio del Duomo di Milano, alcune considerazioni maturate a seguito dei lavori di restauro. *Arte Lombarda*, I semestre: 5–29.
- Ferrari da Passano, C. 1988. *Il Duomo Rinato*. Vigevano, Italy: Diakronia.
- Ferrari da Passano, C., and G. Oberti. 1983. Reconstruction des structures du dôme de Milan. In *IABSE Symposium on Strengthening of Building Structures: Diagnosis and Therapy*. Venice, Italy: International Association for Bridge and Structural Engineering (IABSE), 277–286.
- Fitchen J. 1961. *The construction of gothic cathedrals: A study of medieval vault erection*. London, UK: Oxford University Press.
- Frankl P. 1960. *The Gothic: Literary sources and interpretations through eight centuries*. Princeton, NJ: Princeton University Press, 62–83.
- Giorgetti, P., and L. Postoli. 2012. Analisi dinamica della guglia maggiore del Duomo di Milano soggetta ad azioni sismiche. Politecnico di Milano Master's Thesis. Milan, Italy.
- Giuffrè, A. 1990. *Lecture sulla meccanica delle Murature Storiche*. Facoltà di Architettura dell'Università di Roma La Sapienza, Rom, Italy.
- Heyman J. 1967. On shell solutions for masonry domes. *International Journal of Solids and Structures* 3(3):227–242.
- Heyman J. 1969. The safety of masonry arches. *International Journal of Mechanical Sciences* 11(4):363–385.
- Heyman, J. 1995. *The stone skeleton, structural engineering of masonry architecture*. Cambridge, UK: Cambridge University Press.
- Heyman J. 1996. *Arches, vaults and buttresses. Masonry structures and their engineering* [variorum]. Farnham, Surrey, UK: Ashgate Publishing, Ltd., 139–160.
- Huerta, S. 2001. Mechanics of masonry vaults: the equilibrium approach. In *Historical constructions*. Guimaraes, Portugal: University of Minho, 47–69.
- Huerta, S. 2003. The mechanics of timber vaults, a historical outline. In *Essays in the History of Mechanics*, ed., A. Becchi. Basel, Switzerland: Birkhauser Verlag.
- Istituto Sperimentale Modelli e Strutture (ISMES). 1802 [1982]. *Determinazione del modulo di elasticità' del modulo di rottura di n.10 Provinci di Marmo di Candoglia Pratica Seriate*, Italy: ISMES, CESI. Archive of the Veneranda Fabbrica del Duomo.
- Niccolai, C., 1967. Il sottosuolo del territorio di Milano. *Rivista Italiana di Geotecnica* 1:7–33.
- Roca, P., M. Cervera, G. Gariup, and L. Pelà. 2010. Structural analysis of masonry historical constructions. Classical and advanced approaches. *Archives of Computational Methods in Engineering* 17:299–325.
- Roca, P., M. Cervera, L. Pelà, R. Clemente, and M. Chiumenti. 2013. Continuum FE models for the analysis of Mallorca Cathedral. *Engineering Structures* 46:653–670.
- Romano, A., and J. A. Ochsendorf. 2010. The mechanics of gothic masonry arches. *International Journal of Architectural Heritage* 4(1):59–82.
- Schodek, D. L. 2004. *Structures*. Upper Saddle River, NJ: Pearson-Prentice Hall.
- Smith, N. A. F. 2001. Cathedral studies: Engineering or history. *Transactions of the Newcomen Society* 73:95–137.
- Toniolo, L., T. Poli, C. M. Zerbi, and F. Casadio. 2006. The façade of Milan cathedral: A case of diagnosis for the intervention. In *Proceedings of the International Conference on Heritage, Weathering, and Conservation (HWC) 2006*, June 21–24, 2006, Madrid, Spain. vol. 2, 875–880. London, UK: Taylor & Francis.
- Zandi Hanjari, K. Z., D. Coronelli, and K. Lundgren. 2011. Bond capacity of severely corroded bars with corroded stirrups. *Magazine of Concrete Research* 63(12):953–968.